



General Description

AFE0522 are designed by bi-direction TVS diode, to protect high speed data interfaces. This product has been specifically designed to protect sensitive components which are connected to data and transmission lines from overvoltage caused by ESD (electrostatic discharge), CDE (Cable Discharge Events), and EFT (electrical fast transients).The TVS diode prevents over-voltage on the power line, protecting any downstream components. The low capacitance configuration allows the user to protect high-speed data or transmission lines. This device is optimized for ESD protection of portable electronics. They may be used to meet the ESD immunity requirements of IEC 61000-4-2, Level 4 ($\pm 15\text{kV}$ air, $\pm 8\text{kV}$ contact discharge).

Features

- Transient protection for high-speed data lines to IEC 61000-4-2 (ESD) $\pm 15\text{kV}$ (air), $\pm 8\text{kV}$ (contact) IEC 61000-4-4 (EFT) 40A (5/50ns)
- Small package saves board space
- Protects up to four I/O lines & power line
- Low capacitance (<3pF) for high-speed interfaces
- Low leakage current and clamping voltage
- Low operating voltage: 5.0V
- Solid-state silicon-avalanche technology

Application

- USB 2.0 Power and Data Line Protection
- Monitors and Flat Panel Displays
- Digital Visual Interface (DVI)
- 10/100/1000 Ethernet
- Notebook Computer
- SIM Ports
- ATM Interface
- IEEE 1394 Firewire Ports
- Cellular Handsets & Accessories
- Portable Instrumentation
- Digital Cameras
- MP3 Players
- Video Graphics Cards

Pin Description (SOT-523)

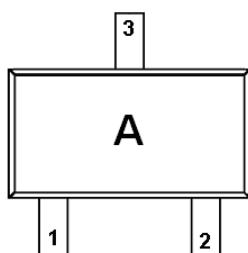

Schematic & PIN Configuration(SOT-523)

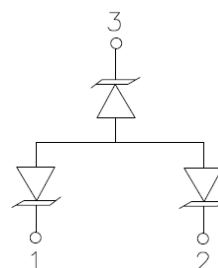

Ordering Information

Part Ordering No.	Part Marking	Package	Unit	Quantity
AFE0522S52RG	A	SOT-523	Tape & Reel	3000 EA

※ AFE0522S52RG : 7" Tape & Reel ; Pb- Free ; Halogen- Free



ABSOLUTE MAXIMUM RATINGS

(T_A=25°C Unless otherwise noted)

Parameter	Symbol	Typical	Unit
Peak Pulse Power (t _p = 8/20 μs)	P _{pk}	100	W
Maximum Peak Pulse Current (t _p = 8/20 μs)	I _{PP}	4	A
ESD per IEC 61000 – 4 – 2 (Air)	V _{PP}	±15	KV
ESD per IEC 61000 – 4 – 2 (Contact)	V _{PP}	±8	KV
Operating Junction Temperature	T _J	-55 ~ 125	°C
Storage Temperature Range	T _{STG}	-55 ~ 150	°C
Lead Soldering Temperature	T _L	260 (10sec)	°C

ELECTRICAL CHARACTERISTICS

(T_A=25°C Unless otherwise noted)

Parameter	Symbol	Conditions	Min.	Typ	Max.	Unit
Reverse Stand – Off Voltage	V _{RWM}	Pin 1 to 2 or Pin 2 to 1			5	V
Reverse Breakdown Voltage	V _{BR}	I _t = 1mA Pin 1 to 2 or Pin 2 to 1	6			V
Reverse Leakage Current	I _R	V _{RWM} = 5V , T=25°C Pin 1 to 2 or Pin 2 to 1		0.5	1.0	μA
Clamping Voltage	V _C	I _{PP} = 1A , t _p = 8/20 μs Pin 1 to 2 or 2 to 1			13	V
Clamping Voltage	V _C	I _{PP} = 4A , t _p = 8/20 μs Pin 1 to 2 or 2 to 1			15	V
Junction Capacitance	C _j	V _R = 0V , f = 1MHz		2	3	pF



Typical Characteristics

Non-Repetitive Peak Pulse Power vs. Pulse Time

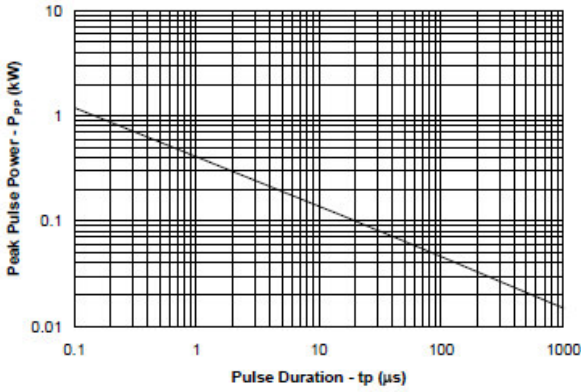

Power Derating Curve

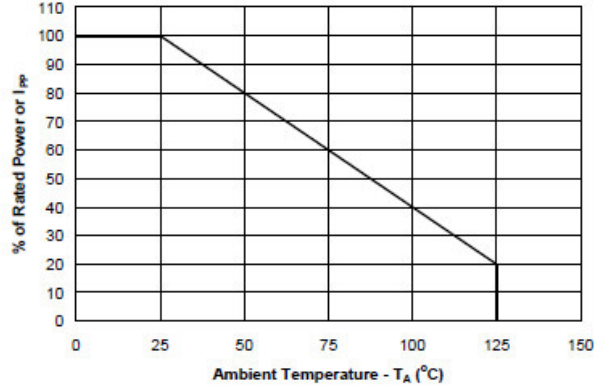

Clamping Voltage vs. Peak Pulse Current

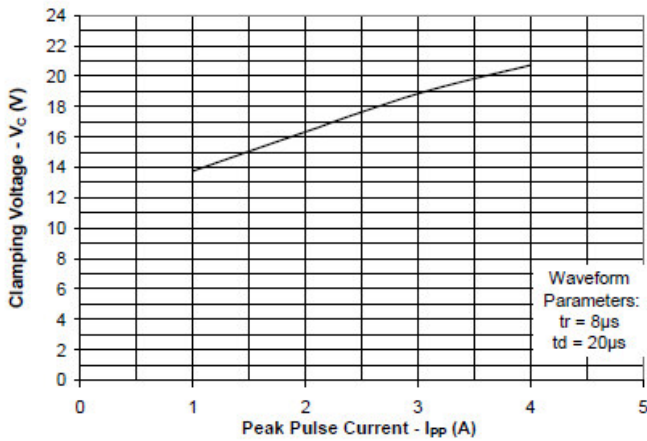

Normalized Capacitance vs. Reverse Voltage

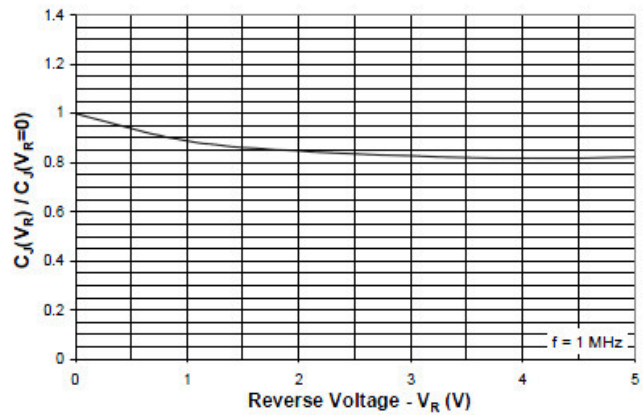



Application Information

Device Connection Options

Device Connection for Protection of Two Data Lines

AFE0522 is designed to protect up to two bidirectional data lines. The device is connected as follows:

1. Bidirectional protection of five I/O lines is achieved by connecting pins 2 and 3 to the data lines. Pin 1 is connected to ground. The ground connection should be made directly to the ground plane for best results. The path length is kept as short as possible to reduce the effects of parasitic inductance in the board traces.

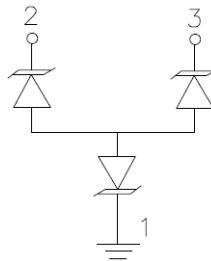

Circuit Board Layout Recommendations for Suppression of ESD.

Good circuit board layout is critical for the suppression of ESD induced transients. The following guidelines are recommended :

- Place the TVS near the input terminals or connectors to restrict transient coupling.
- Minimize the path length between the TVS and the protected line.
- Minimize all conductive loops including power and ground loops.
- The ESD transient return path to ground should be kept as short as possible.
- Never run critical signals near board edges.
- Use ground planes whenever possible.

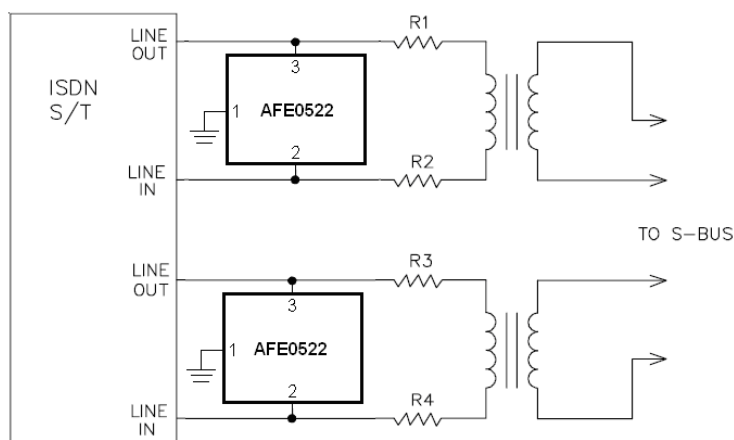

ISDN S/T Interface Protection



Package Information (SOT-523)

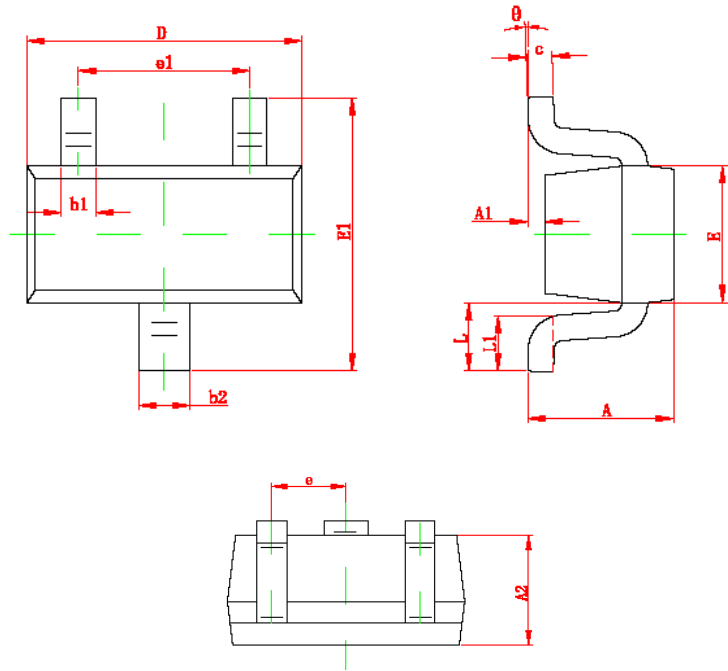

Symbol	Dimensions In Millimeters		Dimensions In Inches	
	Min	Max	Min	Max
A	0.700	0.900	0.028	0.035
A1	0.000	0.100	0.000	0.004
A2	0.700	0.800	0.028	0.031
b1	0.150	0.250	0.006	0.010
b2	0.250	0.325	0.010	0.013
c	0.100	0.200	0.004	0.008
D	1.500	1.700	0.059	0.067
E	0.750	0.850	0.030	0.033
E1	1.450	1.750	0.057	0.069
e	0.500 TYP		0.020 TYP	
e1	0.900	1.100	0.035	0.043
L	0.550 REF		0.022 REF	
L1	0.280	0.440	0.011	0.017
θ	0°	4°	0°	4°

©2010 Alfa-MOS Technology Corp.
 2F, No.80, Sec.1, Cheng Kung Rd., Nan Kang Dist., Taipei City 115, Taiwan (R.O.C.)
 Tel : 886 2) 2651 3928
 Fax : 886 2) 2786 8483
 ©http://www.alfa-mos.com