



### General Description

The AFE0524B is a 4-channel ultra low capacitance rail clamp ESD protection diodes array. Each channel consists of a pair of ESD diodes that steer positive or negative ESD current to either the positive or negative rail. A Zener diode is integrated in to the array between the positive and negative supply rails.

In the typical applications, the negative rail pin (assigned as GND) is connected with system ground. The Positive ESD current is steered to the ground through an ESD diode and Zener diode and the positive ESD voltage is clamped to the Zener voltage.

The AFE0524B is idea to protect high speed data lines. SOT-23-6L package type is provided for easy PCB layout.

### Features

- 4 channels of ESD protection
- Provides ESD protection to IEC61000-4-2 level 4  
±17 KV air discharge  
±12 KV contact discharge
- Channel I/O to GND capacitance: 0.9pF(Max)
- Channel I/O to I/O capacitance: 0.45pF(Max)
- Low clamping voltage
- 5V low operating voltage
- Improved Zener structure
- Optimized package for easy high speed data lines  
PCB layout
- ROHS compliant

### Application

- USB 2.0 Power and Data Line Protection
- Monitors and Flat Panel Displays
- Digital Visual Interface (DVI)
- 10/100/1000 Ethernet
- Notebook Computer
- ATM Interface
- IEEE 1394 Firewire Ports
- MP3 Players
- Video Graphics Cards
- Set-top box

### Pin Description ( SOT-363 )

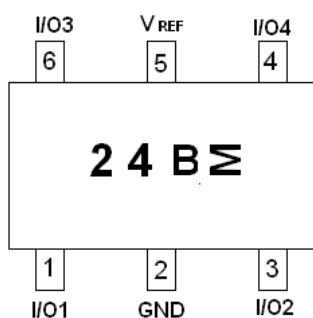

### Schematic & PIN Configuration( SOT-363 )

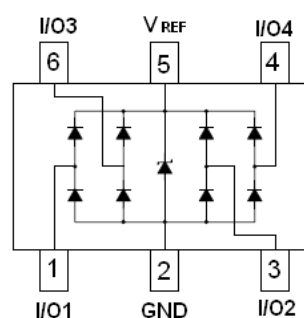

### Ordering Information

Part Ordering No.	Part Marking	Package	Unit	Quantity
AFE0524BS36RG	24BM	SOT-363	Tape & Reel	3000 EA

- ※ 24B Parts code
- ※ M Month code
- ※ AFE0524BS36RG : 7" Tape & Reel ; Pb- Free ; Halogen- Free



**ABSOLUTE MAXIMUM RATINGS**

(T<sub>A</sub>=25°C Unless otherwise noted)

Parameter	Symbol	Typical	Unit
Peak Pulse Power ( t <sub>p</sub> = 8/20 μs )	P <sub>pk</sub>	150	W
Peak Pulse Current ( t <sub>p</sub> = 8/20 μs )	I <sub>PP</sub>	5	A
ESD per IEC 61000 – 4 – 2 (Air )	V <sub>ESD1</sub>	±17	KV
ESD per IEC 61000 – 4 – 2 (Contact )	V <sub>ESD2</sub>	±12	KV
Operating Junction Temperature	T <sub>J</sub>	-55 ~ 125	°C
Storage Temperature Range	T <sub>STG</sub>	-55 ~ 150	°C

**ELECTRICAL CHARACTERISTICS**

(T<sub>A</sub>=25°C Unless otherwise noted)

Parameter	Symbol	Conditions	Min.	Typ	Max.	Unit
Reverse Working Voltage	V <sub>RWM</sub>	Any Pin to GND			5	V
Reverse Breakdown Voltage	V <sub>BR</sub>	I <sub>t</sub> = 1mA Any Pin to GND	6			V
Reverse Leakage Current	I <sub>R</sub>	V <sub>RWM</sub> = 5V , T=25°C Any Pin to GND			1	μA
Positive Clamping Voltage	V <sub>C1</sub>	I <sub>PP</sub> = 1A , t <sub>p</sub> = 8/20 μs Positive pulse Any Pin to GND		8.5	12	V
Negative Clamping Voltage	V <sub>C2</sub>	I <sub>PP</sub> = 1A , t <sub>p</sub> = 8/20 μs Negative pulse Any Pin to GND		1.8		V
Junction Capacitance Between Channel	C <sub>j1</sub>	V <sub>R</sub> = 0V , f = 1MHz Between I/O Pin		0.35	0.45	pF
Junction Capacitance Between I/O to GND	C <sub>j2</sub>	V <sub>R</sub> = 0V , f = 1MHz Any Pin to GND			0.9	pF



### Typical Characteristics

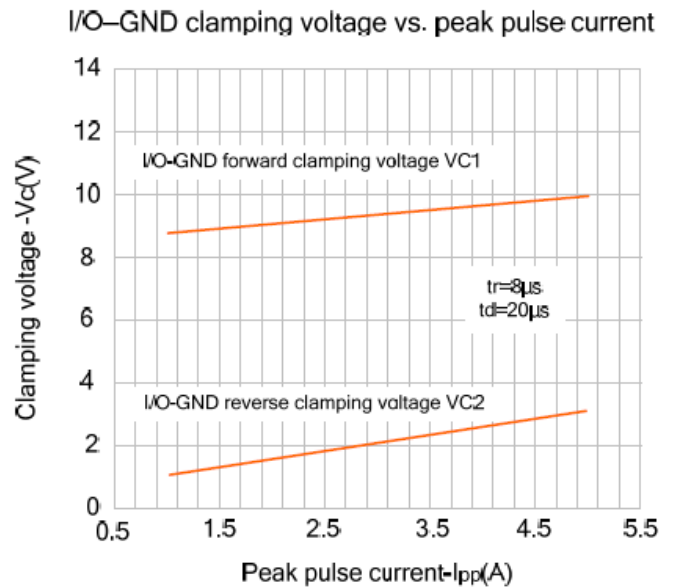
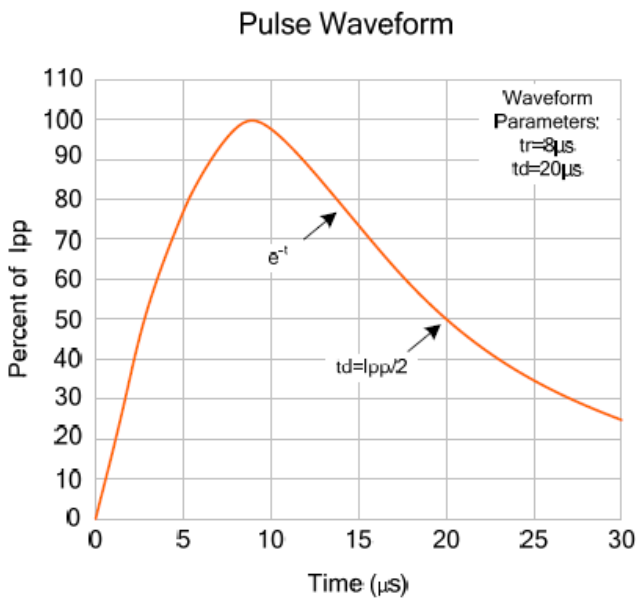
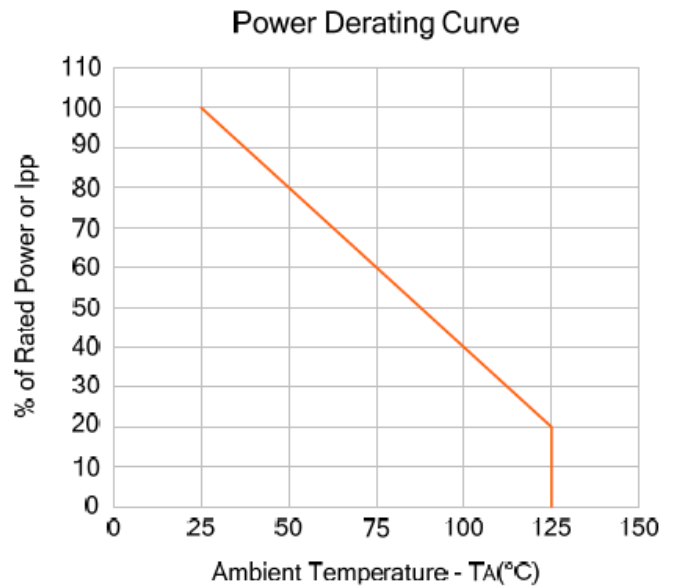
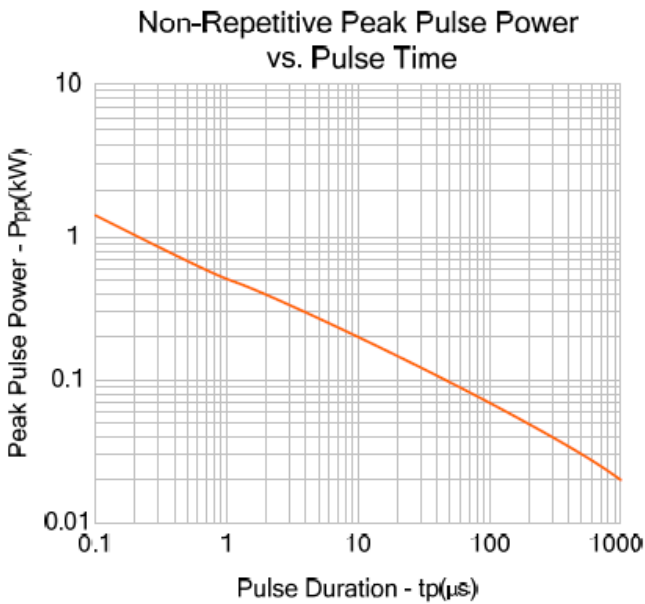



### Typical Characteristics

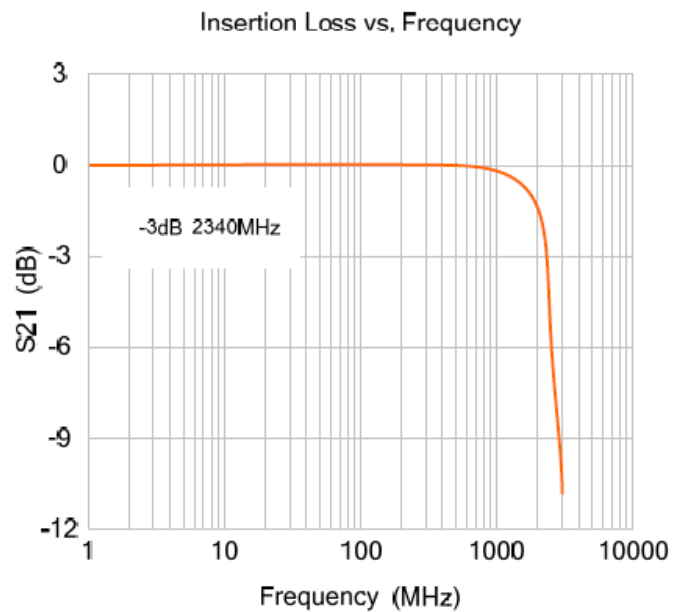
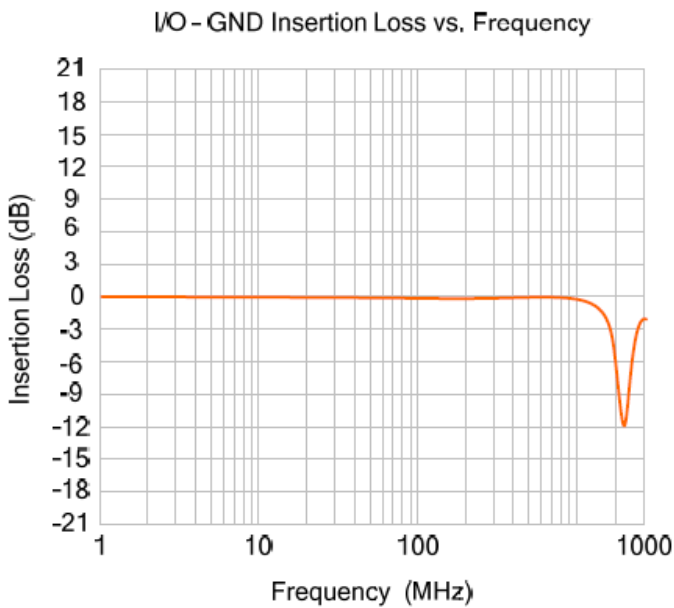
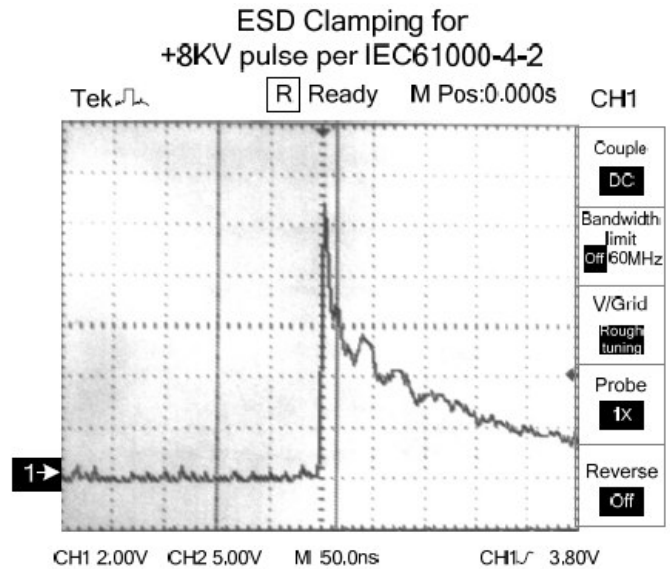
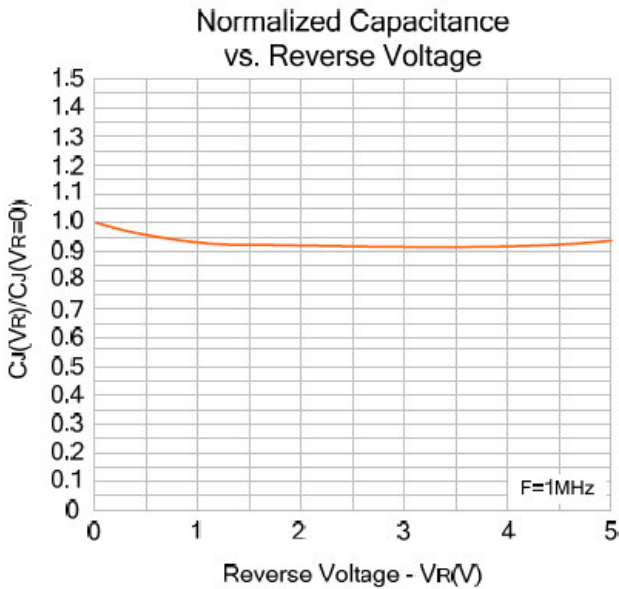



**Package Information ( SOT-363 )**

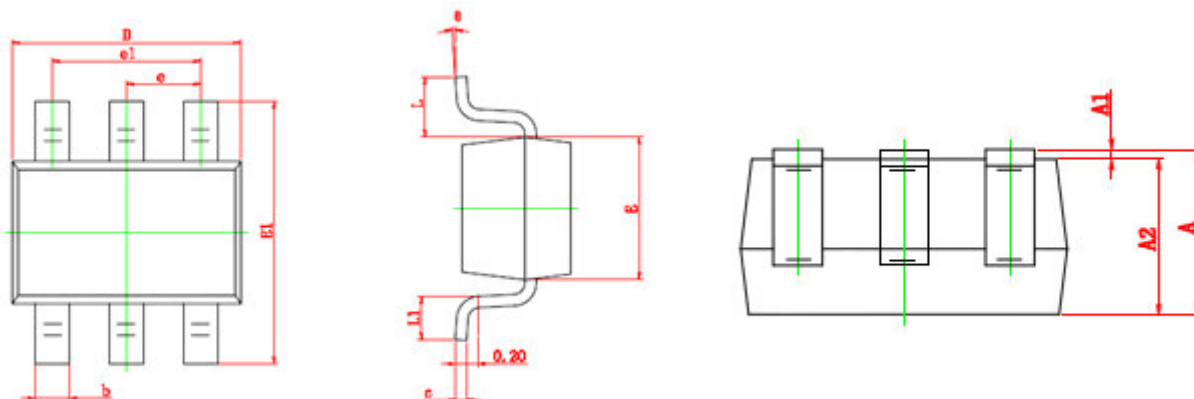

Symbol	Dimensions In Millimeters		Dimensions In Inches	
	Min	Max	Min	Max
A	0.900	1.100	0.035	0.043
A1	0.000	0.100	0.000	0.004
A2	0.900	1.000	0.035	0.039
b	0.150	0.350	0.006	0.014
c	0.080	0.150	0.003	0.006
D	2.000	2.200	0.079	0.087
E	1.150	1.350	0.045	0.053
E1	2.150	2.450	0.085	0.096
e	0.650 TYP		0.026 TYP	
e1	1.200	1.400	0.047	0.055
L	0.525 REF		0.021 REF	
L1	0.260	0.460	0.010	0.018
θ	0°	8°	0°	8°

©2010 Alfa-MOS Technology Corp.  
2F, No.80, Sec.1, Cheng Kung Rd., Nan Kang Dist., Taipei City 115, Taiwan (R.O.C.)  
Tel : 886 2) 2651 3928  
Fax : 886 2) 2786 8483  
©http://www.alfa-mos.com