



General Description

AFC1016E, N & P Pair enhancement mode MOSFET, uses Advanced Trench Technology to provide excellent $R_{DS(ON)}$, low gate charge. These devices are particularly suited for low voltage power management, such as smart phone and notebook computer and other battery powered circuits, and low in-line power loss are needed in commercial industrial surface mount applications.

Features

N-Channel

- 20V/0.6A, $R_{DS(ON)} = 360\text{m}\Omega @ V_{GS} = 4.5\text{V}$
- 20V/0.5A, $R_{DS(ON)} = 420\text{m}\Omega @ V_{GS} = 2.5\text{V}$
- 20V/0.4A, $R_{DS(ON)} = 560\text{m}\Omega @ V_{GS} = 1.8\text{V}$

P-Channel

- -20V/-0.4A, $R_{DS(ON)} = 620\text{m}\Omega @ V_{GS} = -4.5\text{V}$
- -20V/-0.3A, $R_{DS(ON)} = 860\text{m}\Omega @ V_{GS} = -2.5\text{V}$
- -20V/-0.2A, $R_{DS(ON)} = 1450\text{m}\Omega @ V_{GS} = -1.8\text{V}$

Pin Description (SOT-563)

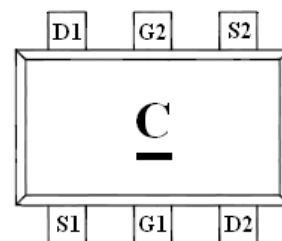
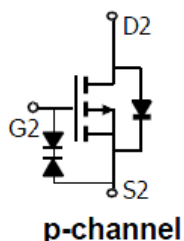
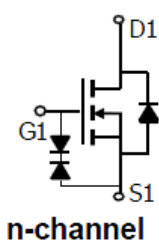
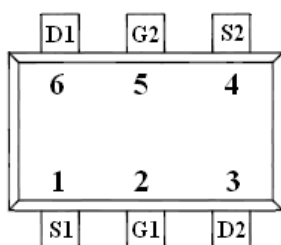

Application

- Battery Operated Systems
- Load/Power Switching Smart Phones, Paggers

Pin Define

Pin	Symbol	Description
1	S1	Source 1
2	G1	Gate 1
3	D2	Drain 2
4	S2	Source 2
5	G2	Gate 2
6	D1	Drain1

Ordering Information

Part Ordering No.	Part Marking	Package	Unit	Quantity
AFC1016ES56RG	C	SOT-563	Tape & Reel	3000 EA

※ AFC1016ES56RG : 7" Tape & Reel ; Pb- Free ; Halogen -Free



Absolute Maximum Ratings (N-Channel)

($T_A=25^{\circ}\text{C}$ Unless otherwise noted)

Parameter	Symbol	Typical	Unit
Drain-Source Voltage	V_{DSS}	20	V
Gate –Source Voltage	V_{GSS}	± 12	V
Continuous Drain Current($T_J=150^{\circ}\text{C}$)	I_D	$T_A=25^{\circ}\text{C}$	0.6
		$T_A=70^{\circ}\text{C}$	0.4
Pulsed Drain Current	I_{DM}	1.0	A
Continuous Source Current(Diode Conduction)	I_S	0.3	A
Power Dissipation	P_D	$T_A=25^{\circ}\text{C}$	0.27
		$T_A=70^{\circ}\text{C}$	0.16
Operating Junction Temperature	T_J	-55/150	$^{\circ}\text{C}$
Storage Temperature Range	T_{STG}	-55/150	$^{\circ}\text{C}$

Electrical Characteristics (N-Channel)

($T_A=25^{\circ}\text{C}$ Unless otherwise noted)

Parameter	Symbol	Conditions	Min.	Typ	Max.	Unit
Static						
Drain-Source Breakdown Voltage	$V_{(BR)DSS}$	$V_{GS}=0V, I_D=250\mu A$	20			V
Gate Threshold Voltage	$V_{GS(th)}$	$V_{DS}=V_{GS}, I_D=250\mu A$	0.4		1.0	
Gate Leakage Current	I_{GSS}	$V_{DS}=0V, V_{GS}=\pm 12V$			± 100	nA
Zero Gate Voltage Drain Current	I_{DSS}	$V_{DS}=20V, V_{GS}=0V$			1	uA
		$V_{DS}=20V, V_{GS}=0V$ $T_J=85^{\circ}\text{C}$			5	
On-State Drain Current	$I_{D(on)}$	$V_{DS} \geq 5V, V_{GS}=4.5V$	0.7			A
Drain-Source On-Resistance	$R_{DS(on)}$	$V_{GS}=4.5V, I_D=0.6A$		240	360	m Ω
		$V_{GS}=2.5V, I_D=0.5A$		300	420	
		$V_{GS}=1.8V, I_D=0.4A$		420	560	
Forward Transconductance	g_{FS}	$V_{DS}=10V, I_D=0.4A$		1		S
Diode Forward Voltage	V_{SD}	$I_S=0.15A, V_{GS}=0V$		0.8	1.2	V
Dynamic						
Input Capacitance	C_{iss}	$V_{DS}=10V, V_{GS}=0V$ $f=1\text{MHz}$		70		pF
Output Capacitance	C_{oss}			20		
Reverse Transfer Capacitance	C_{rss}			8		
Total Gate Charge	Q_g	$V_{DS}=10V, V_{GS}=4.5V$ $I_D=0.6A$		1.06	1.38	nC
Gate-Source Charge	Q_{gs}			0.18		
Gate-Drain Charge	Q_{gd}			0.32		
Turn-On Time	$t_{d(on)}$	$V_{DD}=10V, R_L=20\Omega$ $I_D=0.5A, V_{GEN}=4.5V$ $R_G=1\Omega$		18	26	ns
	t_r			20	28	
Turn-Off Time	$t_{d(off)}$			70	110	
	t_f			25	40	



Absolute Maximum Ratings (P-Channel)

(T_A=25°C Unless otherwise noted)

Parameter	Symbol	Typical	Unit
Drain-Source Voltage	V _{DSS}	-20	V
Gate –Source Voltage	V _{GSS}	±12	V
Continuous Drain Current(T _J =150°C)	I _D	T _A =25°C	-0.4
		T _A =70°C	-0.2
Pulsed Drain Current	I _{DM}	-1.0	A
Continuous Source Current(Diode Conduction)	I _S	-0.3	A
Power Dissipation	P _D	T _A =25°C	0.27
		T _A =70°C	0.16
Operating Junction Temperature	T _J	-55/150	°C
Storage Temperature Range	T _{STG}	-55/150	°C

Electrical Characteristics (P-Channel)

(T_A=25°C Unless otherwise noted)

Parameter	Symbol	Conditions	Min.	Typ	Max.	Unit
Static						
Drain-Source Breakdown Voltage	V _{(BR)DSS}	V _{GS} =0V, I _D =-250uA	-20			V
Gate Threshold Voltage	V _{GS(th)}	V _{DS} =V _{GS} , I _D =-250uA	-0.4		-1.0	
Gate Leakage Current	I _{GSS}	V _{DS} =0V, V _{GS} =±12V			±100	nA
Zero Gate Voltage Drain Current	I _{DSS}	V _{DS} =-20V, V _{GS} =0V			-1	uA
		V _{DS} =-20V, V _{GS} =0V T _J =85°C			-5	
On-State Drain Current	I _{D(on)}	V _{DS} ≥ 5V, V _{GS} =4.5V	0.7			A
Drain-Source On-Resistance	R _{DS(on)}	V _{GS} =-4.5V, I _D =-0.4A		500	620	mΩ
		V _{GS} =-2.5V, I _D =-0.3A		700	860	
		V _{GS} =-1.8V, I _D =-0.2A		1000	1450	
Forward Transconductance	g _{FS}	V _{DS} =-10V, I _D =-0.4A		1		S
Diode Forward Voltage	V _{SD}	I _S =-0.15A, V _{GS} =0V		0.65	1.2	V
Dynamic						
Input Capacitance	C _{iss}	V _{DS} =-10V, V _{GS} =0V f=1MHz		70	100	pF
Output Capacitance	C _{oss}			20		
Reverse Transfer Capacitance	C _{rss}			10		
Total Gate Charge	Q _g	V _{DS} =-10V, V _{GS} =-4.5V I _D ≡-0.25A		1.0	1.3	nC
Gate-Source Charge	Q _{gs}			0.1		
Gate-Drain Charge	Q _{gd}			0.3		
Turn-On Time	t _{d(on)}	V _{DD} =-10V, R _L =30Ω I _D ≡-0.2A, V _{GEN} =-4.5V R _G =10Ω		10	15	ns
	t _r			10	15	
Turn-Off Time	t _{d(off)}			40	60	
	t _f			30	50	



Typical Characteristics (N-Channel)

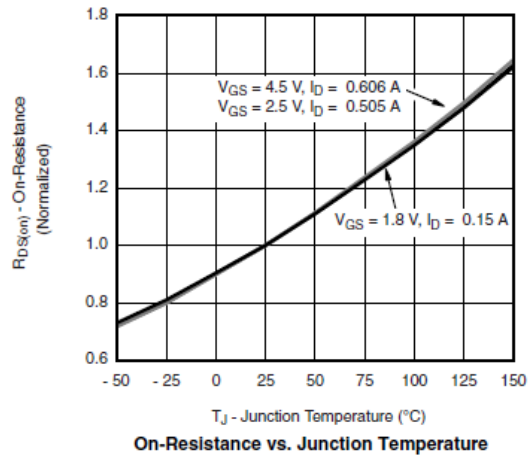
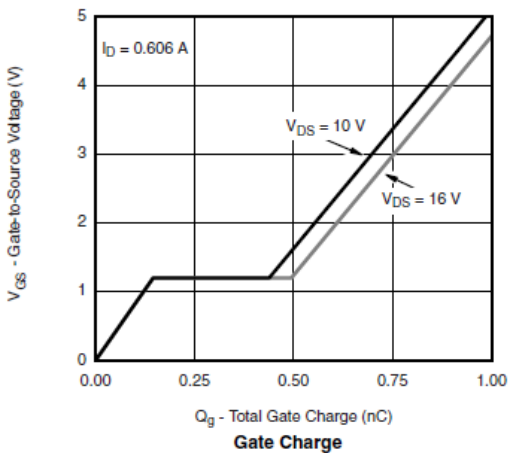
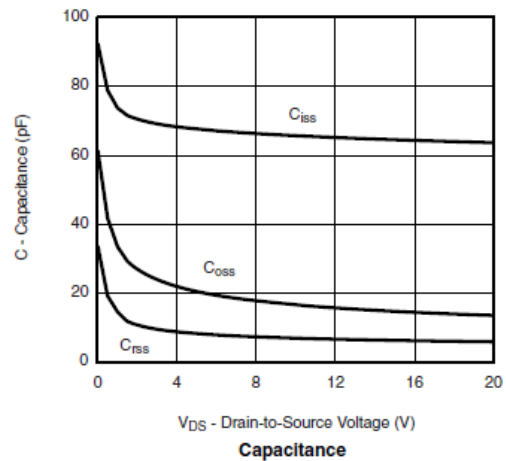
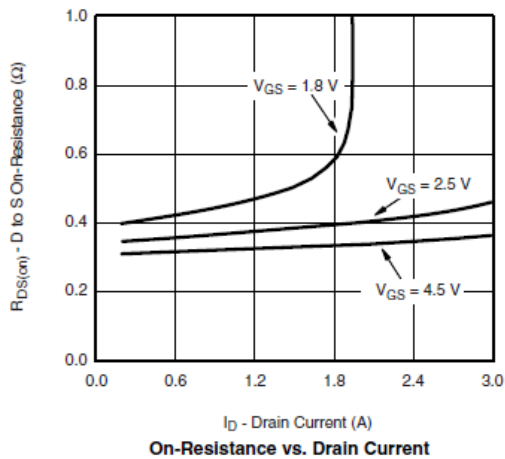
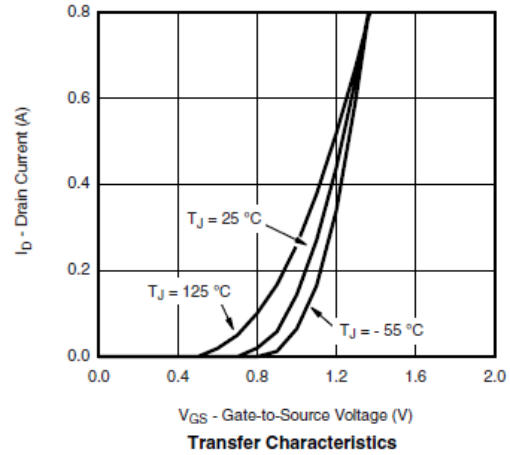
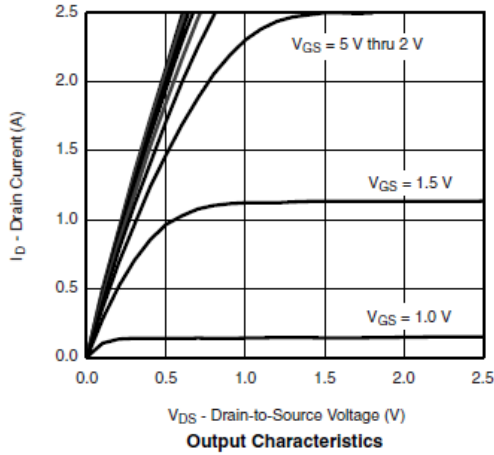



Typical Characteristics (N-Channel)

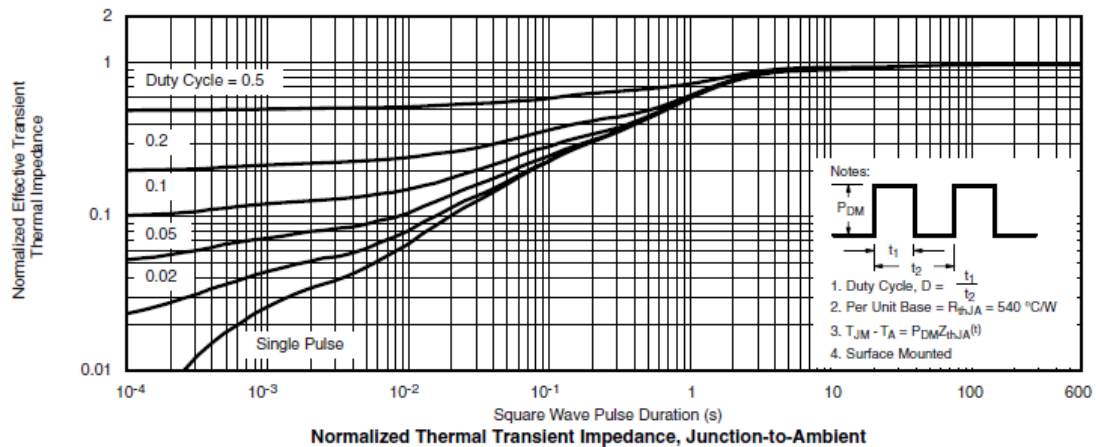
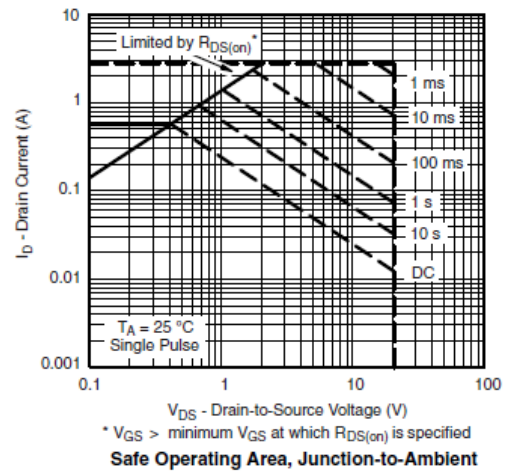
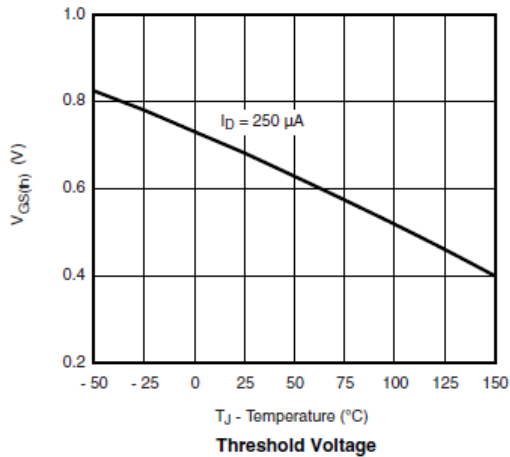
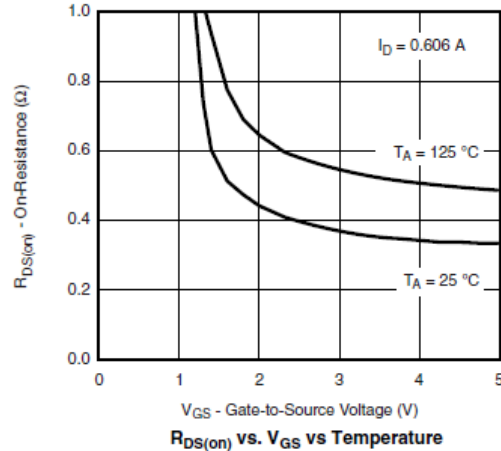
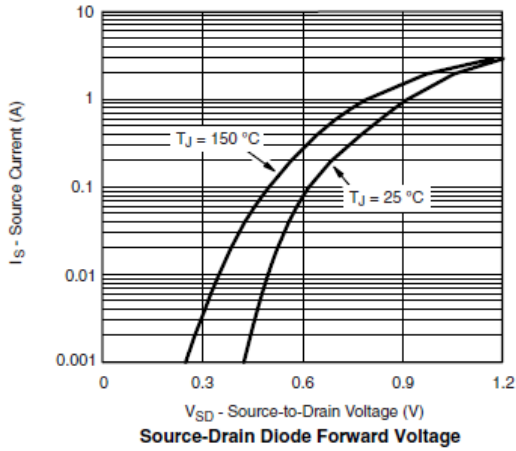



Typical Characteristics (N-Channel)

Gate Charge Test Circuit & Waveform

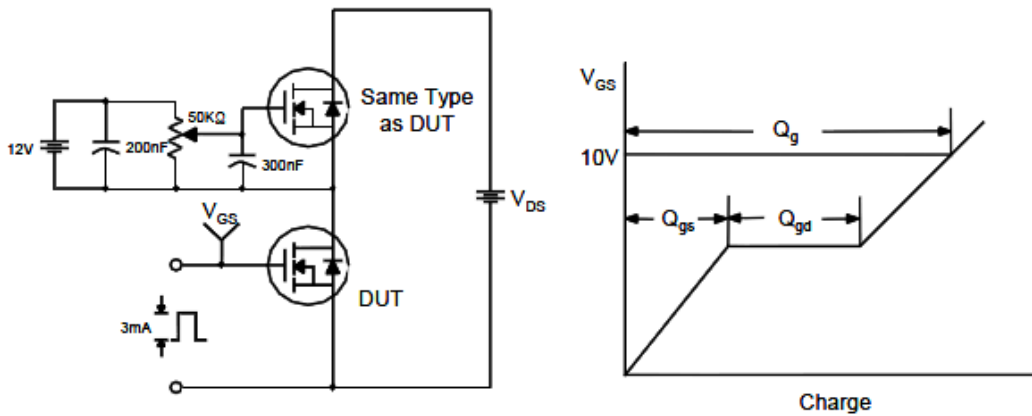

Resistive Switching Test Circuit & Waveforms

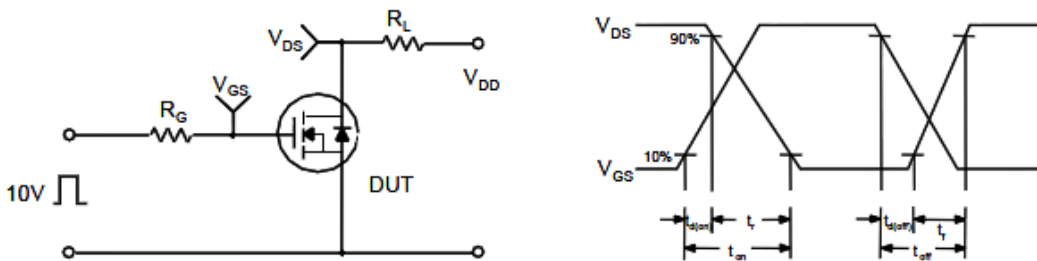

Unclamped Inductive Switching Test Circuit & Waveforms

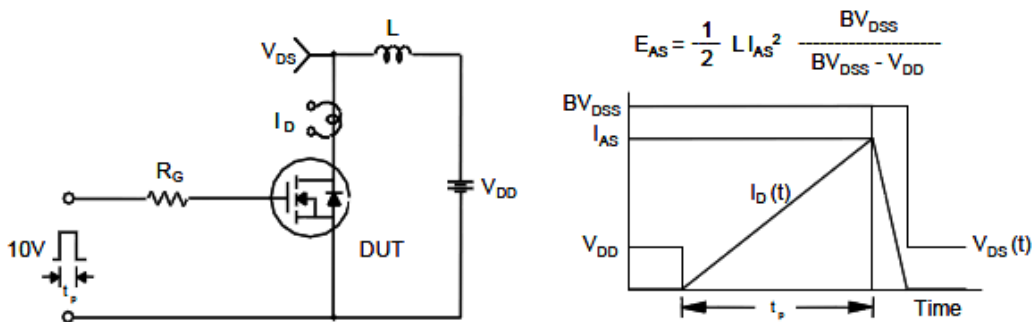



Typical Characteristics (P-Channel)

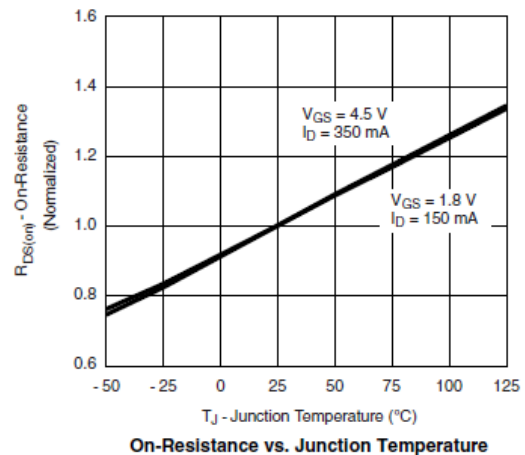
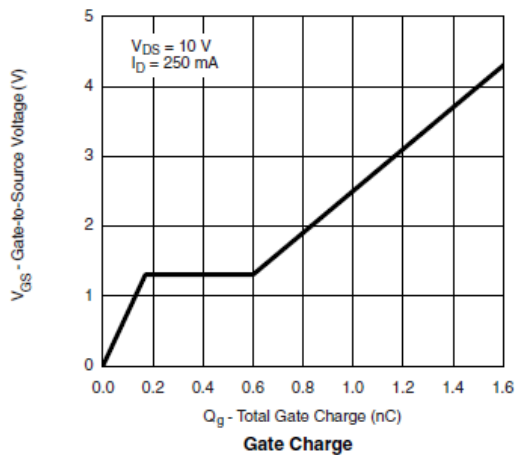
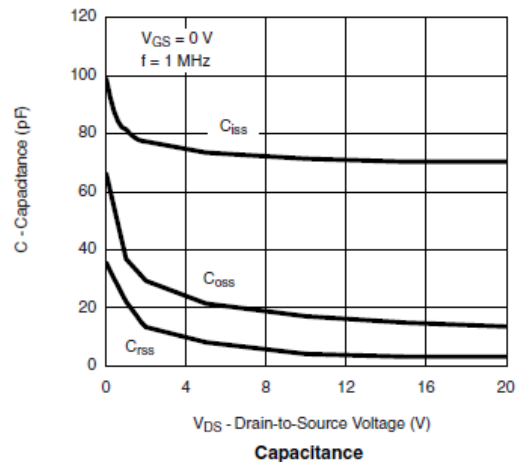
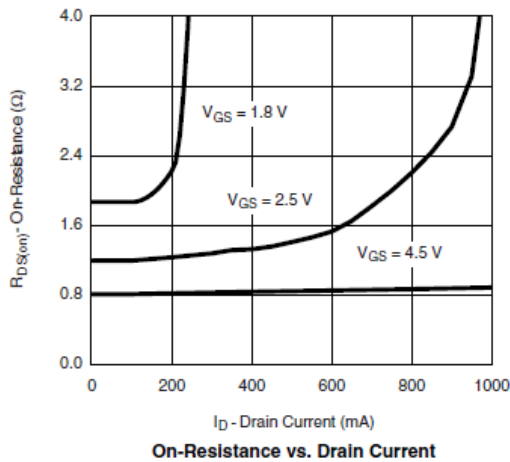
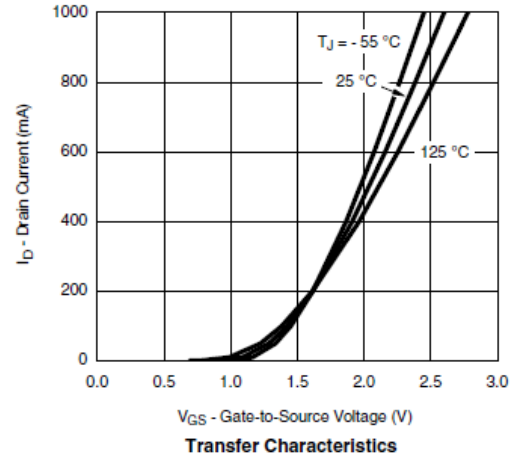
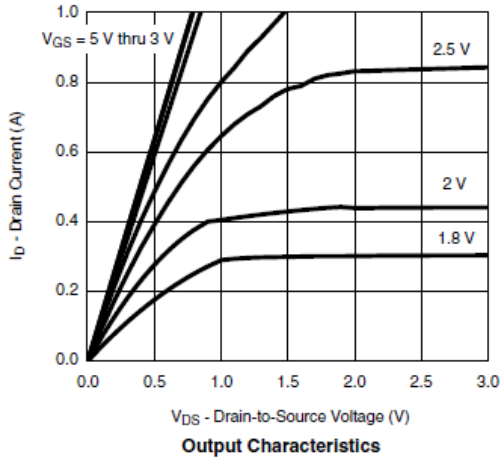



Typical Characteristics (P-Channel)

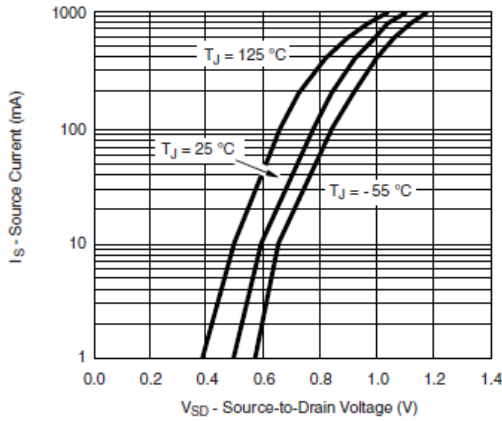

Source-Drain Diode Forward Voltage

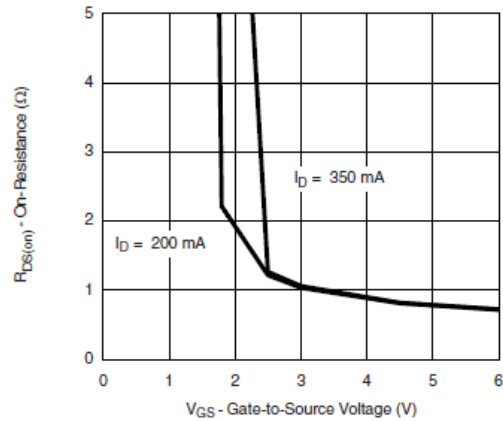

On-Resistance vs. Gate-to-Source Voltage

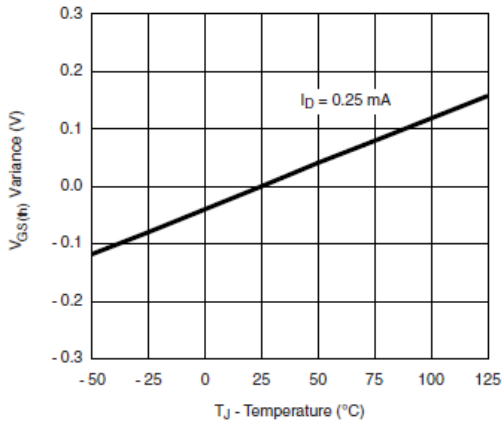

Threshold Voltage Variance vs. Temperature

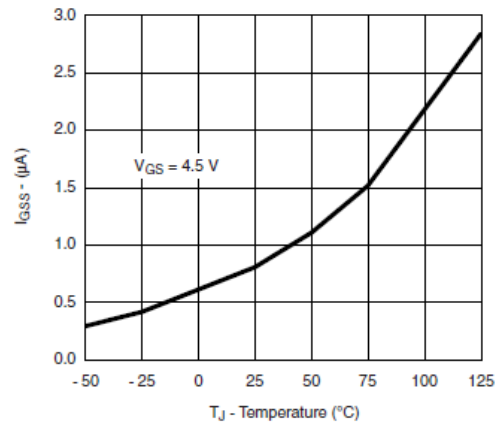

I_{GSS} vs. Temperature

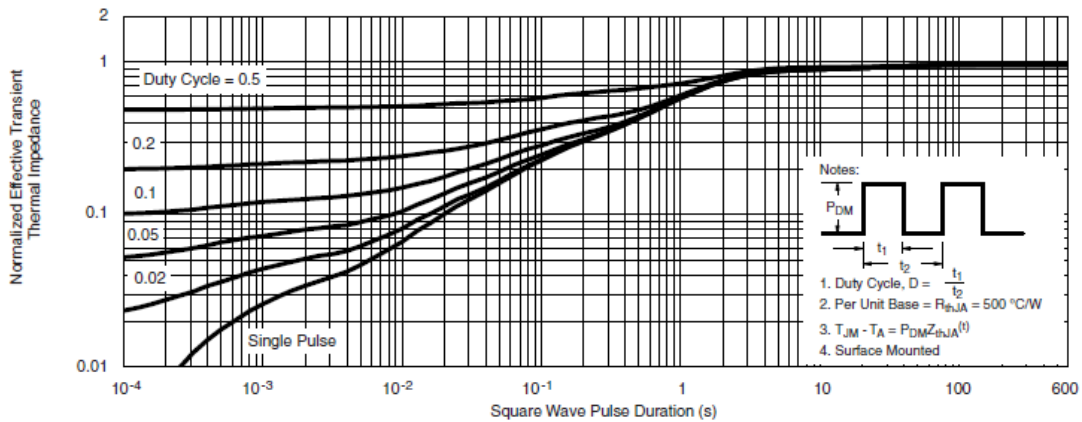

Normalized Thermal Transient Impedance, Junction-to-Ambient



Typical Characteristics (P-Channel)

Gate Charge Test Circuit & Waveform

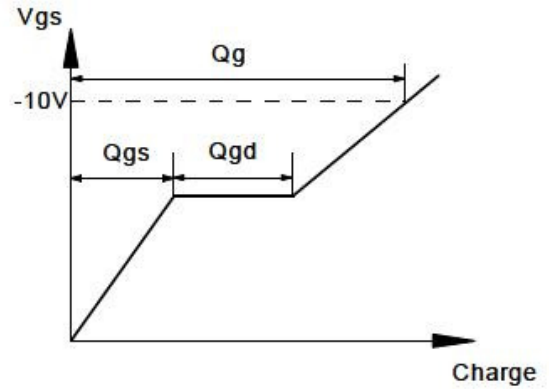
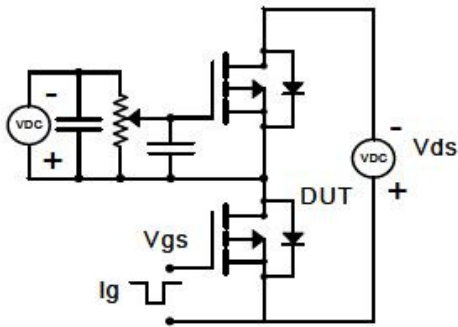

Resistive Switching Test Circuit & Waveforms

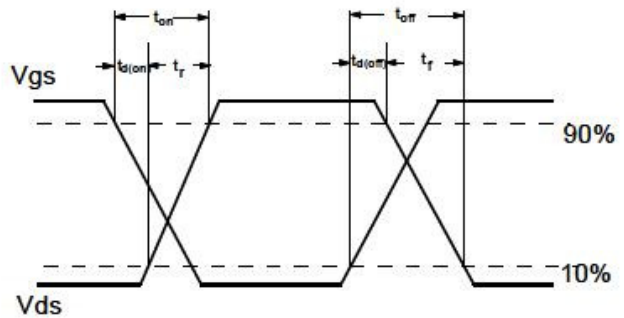
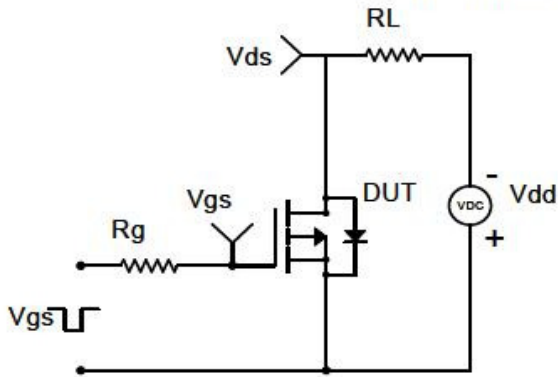

Diode Recovery Test Circuit & Waveforms

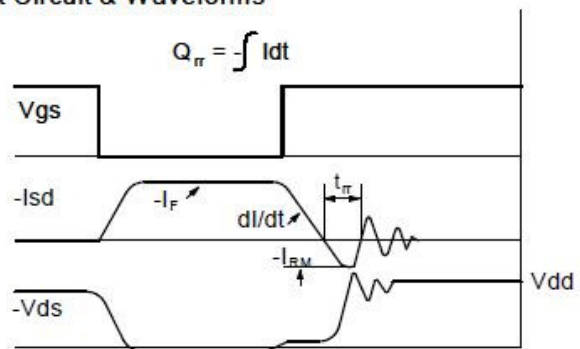
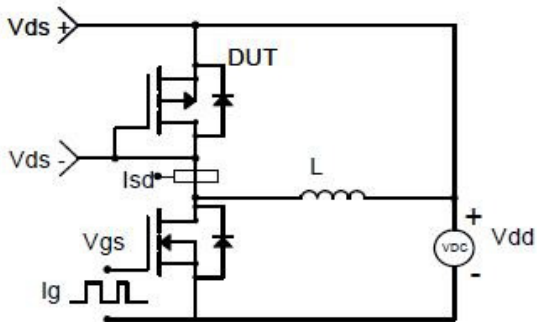



Package Information (SOT-563)

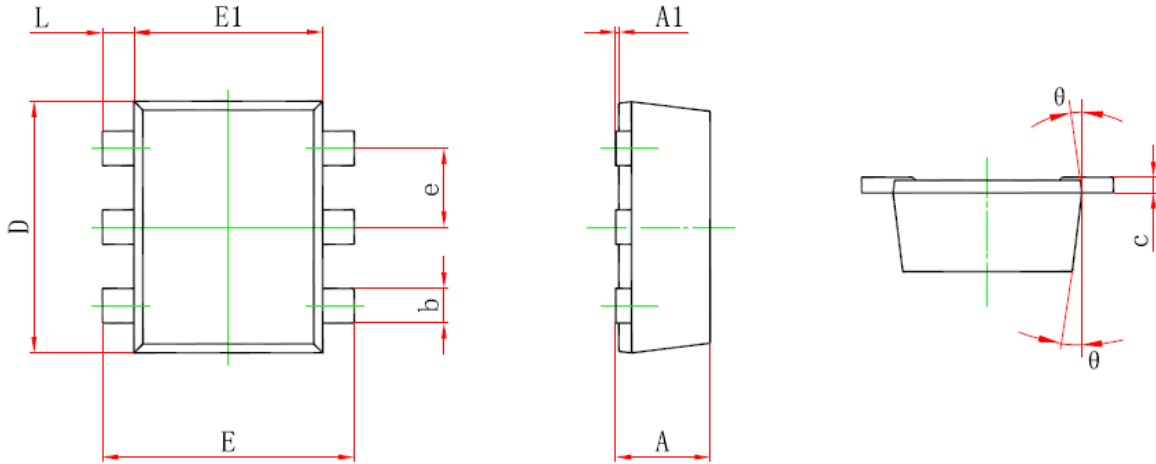

Symbol	Dimensions In Millimeters		Dimensions In Inches	
	Min.	Max.	Min.	Max.
A	0.525	0.600	0.021	0.024
A1	0.000	0.050	0.000	0.002
e	0.450	0.550	0.018	0.022
c	0.090	0.160	0.004	0.006
D	1.500	1.700	0.059	0.067
b	0.170	0.270	0.007	0.011
E1	1.100	1.300	0.043	0.051
E	1.500	1.700	0.059	0.067
L	0.100	0.300	0.004	0.012
θ	7° REF.		7° REF.	

©2010 Alfa-MOS Technology Corp.

2F, No.80, Sec.1, Cheng Kung Rd., Nan Kang Dist., Taipei City 115, Taiwan (R.O.C.)

Tel : 886 2) 2651 3928

Fax : 886 2) 2786 8483

©http://www.alfa-mos.com