



General Description

AFN1432, N-Channel enhancement mode MOSFET, uses Advanced Trench Technology to provide excellent $R_{DS(ON)}$, low gate charge.

These devices are particularly suited for low voltage power management, such as smart phone and notebook computer and other battery powered circuits, and low in-line power loss are needed in commercial industrial surface mount applications.

Features

- 30V/4.0A, $R_{DS(ON)}=30m\Omega@V_{GS}=10V$
- 30V/3.5A, $R_{DS(ON)}=35m\Omega@V_{GS}=4.5V$
- Super high density cell design for extremely low $R_{DS(ON)}$
- Exceptional on-resistance and maximum DC current capability
- SOT-363 package design

Pin Description (SOT-363)

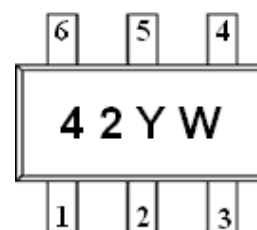
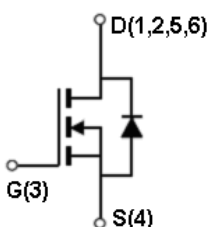
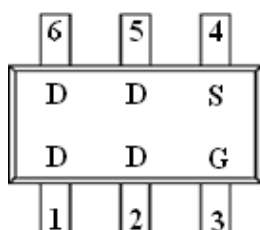

Application

- Power Management in Note book
- LED Display
- DC-DC System
- LCD Panel

Pin Define

Pin	Symbol	Description
1	D	Drain
2	D	Drain
3	G	Gate
4	S	Source
5	D	Drain
6	D	Drain

Ordering Information

Part Ordering No.	Part Marking	Package	Unit	Quantity
AFN1432S36RG	42YW	SOT-363	Tape & Reel	3000 EA

- ※ 42 parts code
- ※ Y year code (0 ~ 9)
- ※ W week code (A ~ Z = 1 ~ 26 / a ~ z = 27 ~ 52)
- ※ AFN1432S36RG : 7" Tape & Reel ; Pb- Free ; Halogen- Free



Absolute Maximum Ratings

(T_A=25°C Unless otherwise noted)

Parameter	Symbol	Typical	Unit
Drain-Source Voltage	V _{DSS}	30	V
Gate –Source Voltage	V _{GSS}	±20	V
Continuous Drain Current(T _J =150°C)	I _D	T _A =25°C	4.0
		T _A =70°C	3.6
Pulsed Drain Current	I _{DM}	15	A
Continuous Source Current(Diode Conduction)	I _S	1.3	A
Power Dissipation	P _D	T _A =25°C	1.56
		T _A =70°C	1.0
Operating Junction Temperature	T _J	150	°C
Storage Temperature Range	T _{STG}	-55/150	°C
Thermal Resistance-Junction to Ambient	R _{θJA}	120	°C/W

Electrical Characteristics

(T_A=25°C Unless otherwise noted)

Parameter	Symbol	Conditions	Min.	Typ	Max.	Unit
Static						
Drain-Source Breakdown Voltage	V _{(BR)DSS}	V _{GS} =0V, I _D =250uA	30			V
Gate Threshold Voltage	V _{GS(th)}	V _{DS} =V _{GS} , I _D =250uA	1.0		2.0	V
Gate Leakage Current	I _{GSS}	V _{DS} =0V, V _{GS} =±20V			±100	nA
Zero Gate Voltage Drain Current	I _{DSS}	V _{DS} =24V, V _{GS} =0V			1	uA
		V _{DS} =24V, V _{GS} =0V T _J =85°C			30	
On-State Drain Current	I _{D(on)}	V _{DS} ≥ 4.5V, V _{GS} =10V	6			A
Drain-Source On-Resistance	R _{DS(on)}	V _{GS} =10V, I _D =4.0A		20	30	mΩ
		V _{GS} =4.5V, I _D =3.5A		25	35	
Forward Transconductance	g _{FS}	V _{DS} =4.5V, I _D =2.5A		8		S
Diode Forward Voltage	V _{SD}	I _S =1.6A, V _{GS} =0V		0.8	1.2	V
Dynamic						
Total Gate Charge	Q _g	V _{DS} =15V, V _{GS} =10V I _D ≅2.6A		3.0	4.5	nC
Gate-Source Charge	Q _{gs}			1.6		
Gate-Drain Charge	Q _{gd}			0.6		
Input Capacitance	C _{iss}	V _{DS} =15V, V _{GS} =0V f=1MHz		320		pF
Output Capacitance	C _{oss}			70		
Reverse Transfer Capacitance	C _{rss}			30		
Turn-On Time	t _{d(on)}	V _{DD} =15V, R _L =15Ω I _D ≅1.0A, V _{GEN} =10V R _G =6Ω		8	12	ns
	t _r			12	18	
Turn-Off Time	t _{d(off)}			15	30	
	t _f			8	15	



Typical Characteristics

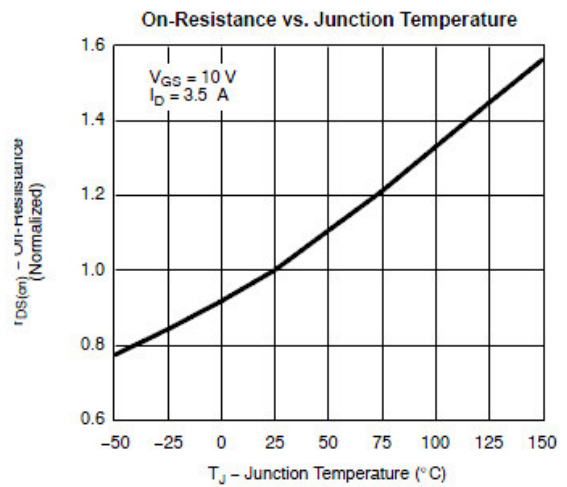
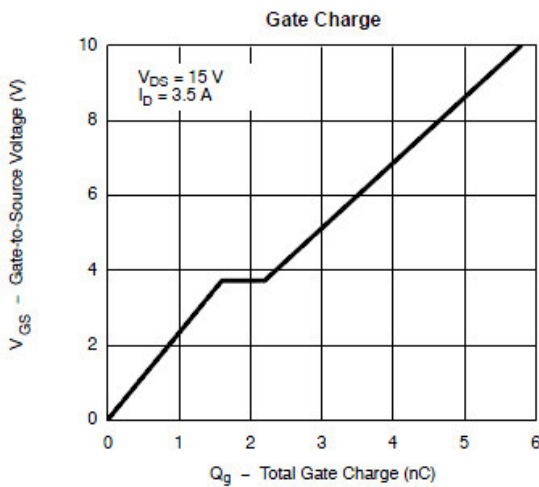
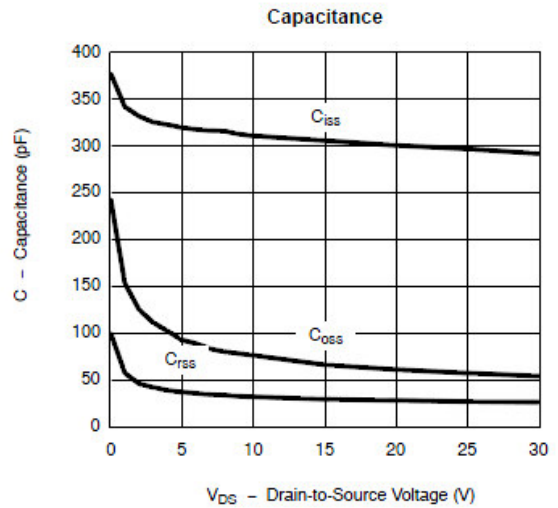
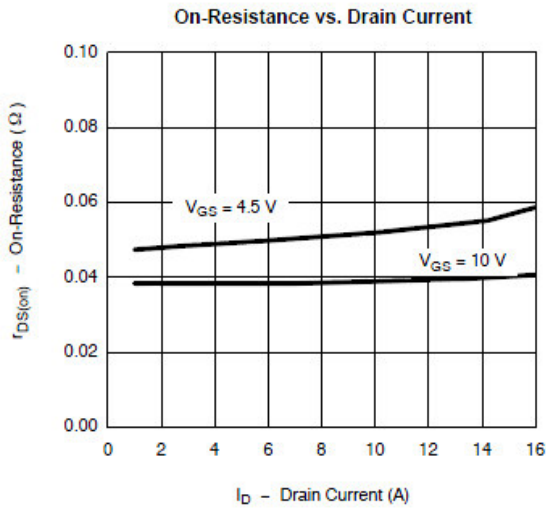
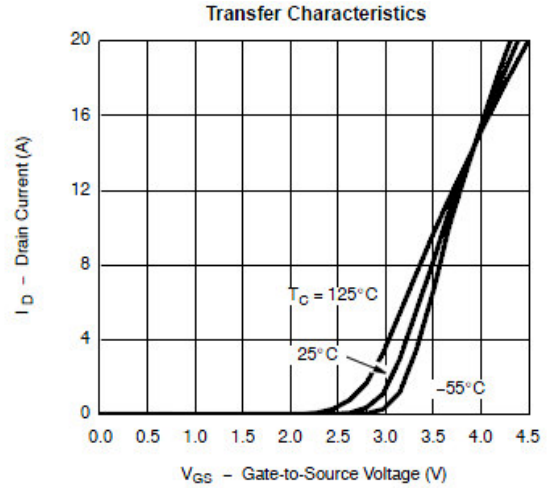
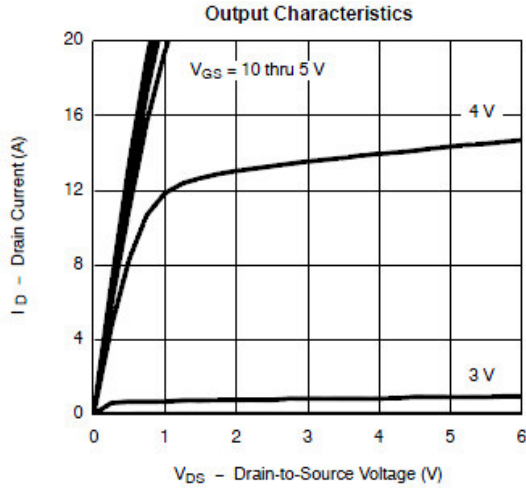



Typical Characteristics

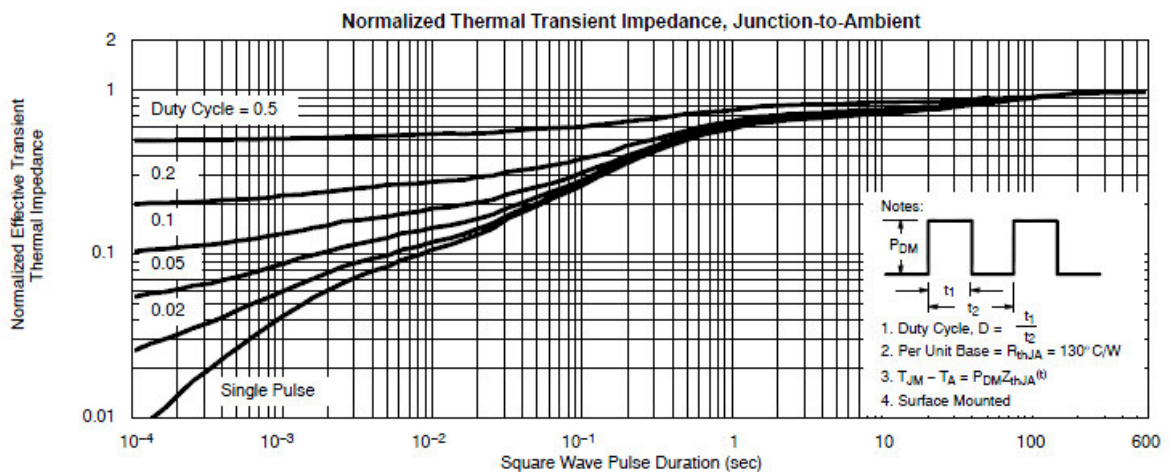
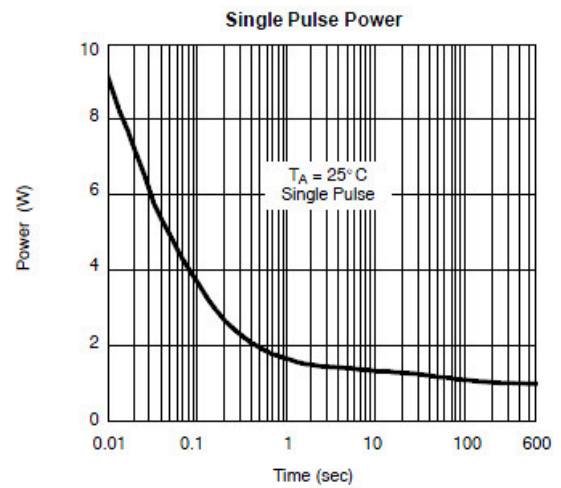
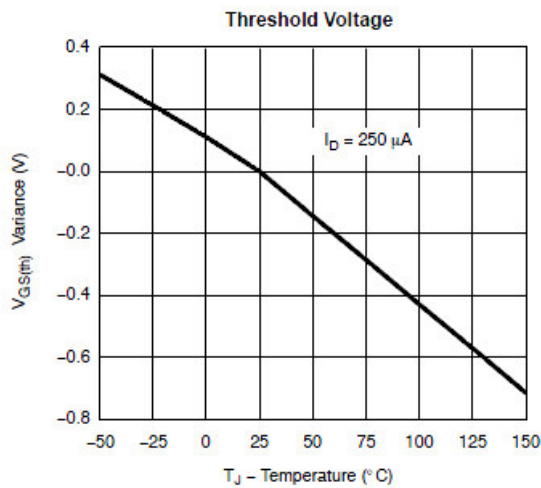
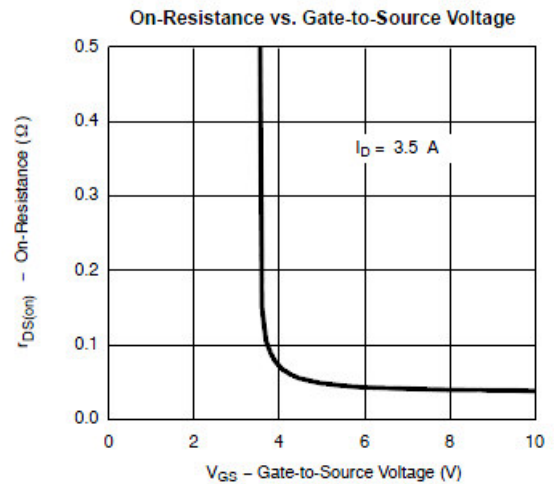
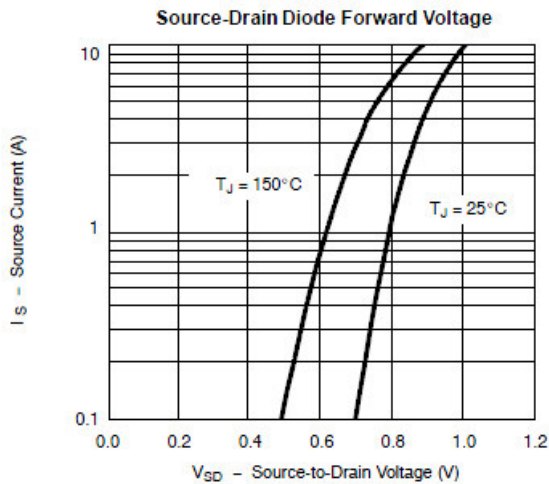



Typical Characteristics

Gate Charge Test Circuit & Waveform



Resistive Switching Test Circuit & Waveforms

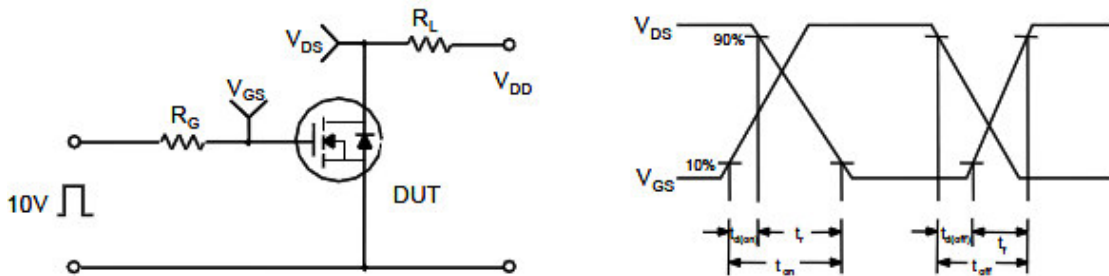

Unclamped Inductive Switching Test Circuit & Waveforms

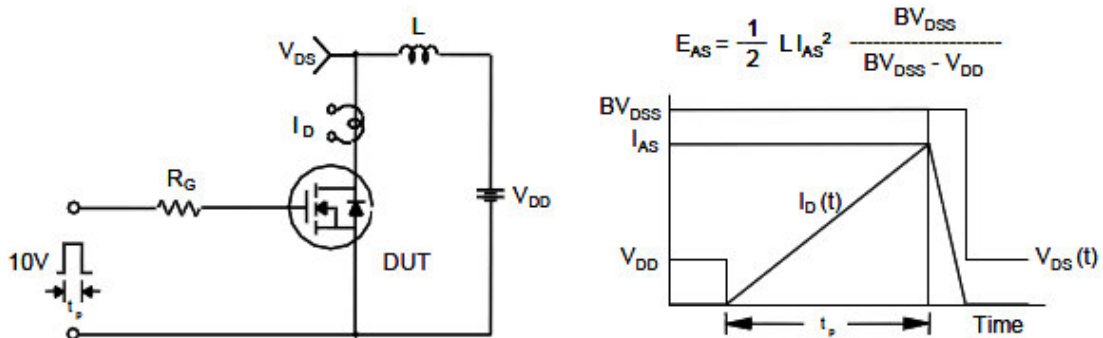



Package Information (SOT-363)

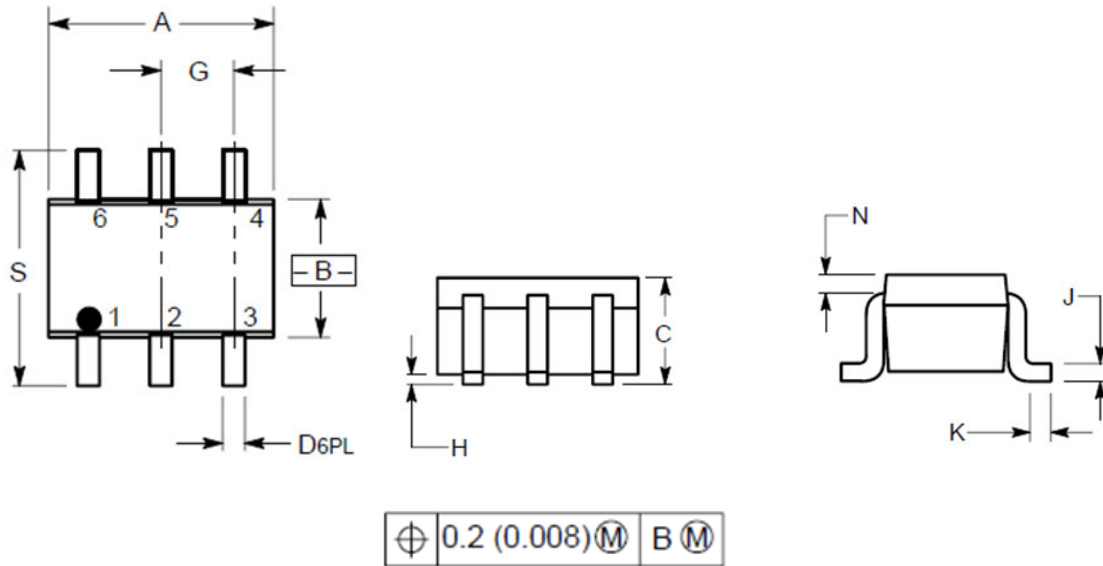

DIM	INCHES		MILLIMETERS	
	MIN	MAX	MIN	MAX
A	0.071	0.087	1.80	2.20
B	0.045	0.053	1.15	1.35
C	0.031	0.043	0.80	1.10
D	0.004	0.012	0.10	0.30
G	0.026 BSC		0.65 BSC	
H	---	0.004	---	0.10
J	0.004	0.010	0.10	0.25
K	0.004	0.012	0.10	0.30
N	0.008 REF		0.20 REF	
S	0.079	0.087	2.00	2.20

©2010 Alfa-MOS Technology Corp.
 2F, No.80, Sec.1, Cheng Kung Rd., Nan Kang Dist., Taipei City 115, Taiwan (R.O.C.)
 Tel : 886 2) 2651 3928
 Fax : 886 2) 2786 8483
 ©http://www.alfa-mos.com