



General Description

AFN3015S, N-Channel enhancement mode MOSFET, uses Advanced Trench Technology to provide excellent $R_{DS(ON)}$, low gate charge. These devices are particularly suited for low voltage power management, and low in-line power loss are needed in commercial industrial surface mount applications.

Features

- 30V/45A, $R_{DS(ON)}=5.1m\Omega@V_{GS}=10V$
- 30V/30A, $R_{DS(ON)}=6.8m\Omega@V_{GS}=4.5V$
- Super high density cell design for extremely low $R_{DS(ON)}$
- TO-252-2L package design

Pin Description (TO-252-2L)

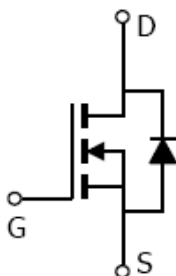
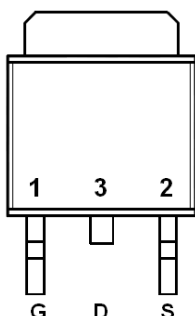

Application

- Buck Converter
 - High Side
 - Low Side
- Synchronous Rectifier
 - Secondary Rectifier

Pin Define

Pin	Symbol	Description
1	G	Gate
2	S	Source
3	D	Drain

Ordering Information

Part Ordering No.	Part Marking	Package	Unit	Quantity
AFN3015ST252RG	3015S	TO-252-2L	Tape & Reel	2500 EA

- ※ A Lot code
- ※ B Date code
- ※ AFN3015ST252RG : 13" Tape & Reel ; Pb- Free ; Halogen -Free



Absolute Maximum Ratings

(T_A=25°C Unless otherwise noted)

Parameter	Symbol	Value	Unit
Drain-Source Voltage	V _{DSS}	30	V
Gate –Source Voltage	V _{GSS}	±20	V
Continuous Drain Current(T _J =150°C)	I _D	T _A =25°C	75
		T _A =70°C	55
Pulsed Drain Current	I _{DM}	200	A
Continuous Source Current(Diode Conduction)	I _S	9.0	A
Power Dissipation	P _D	T _A =25°C	40
		T _A =70°C	15
Operating Junction Temperature	T _J	150	°C
Storage Temperature Range	T _{STG}	-55/150	°C
Thermal Resistance-Junction to Ambient	R _{θJA}	62.5	°C/W

Electrical Characteristics

(T_A=25°C Unless otherwise noted)

Parameter	Symbol	Conditions	Min.	Typ	Max.	Unit
Static						
Drain-Source Breakdown Voltage	V _{(BR)DSS}	V _{GS} =0V, I _D =250uA	30			V
Gate Threshold Voltage	V _{GS(th)}	V _{DS} =V _{GS} , I _D =250uA	1.0		2.0	
Gate Leakage Current	I _{GSS}	V _{DS} =0V, V _{GS} =±20V			±100	nA
Zero Gate Voltage Drain Current	I _{DSS}	V _{DS} =24V, V _{GS} =0V			1	uA
		V _{DS} =24V, V _{GS} =0V T _J =85°C			10	
On-State Drain Current	I _{D(on)}	V _{DS} ≥ 5V, V _{GS} =10V	15			A
Drain-Source On-Resistance	R _{DS(on)}	V _{GS} =10V, I _D =45A		3.6	5.1	mΩ
		V _{GS} =4.5V, I _D =30A		5.1	6.8	
Forward Transconductance	g _{FS}	V _{DS} =15V, I _D =20A		24		S
Diode Forward Voltage	V _{SD}	I _S =30A, V _{GS} =0V		0.8	1.3	V
Dynamic						
Total Gate Charge	Q _g	V _{DS} =15V, V _{GS} =10V I _D ≒40A		50	70	nC
Gate-Source Charge	Q _{gs}			10		
Gate-Drain Charge	Q _{gd}			8		
Input Capacitance	C _{iss}	V _{DS} =25V, V _{GS} =0V f=1MHz		2800		pF
Output Capacitance	C _{oss}			550		
Reverse Transfer Capacitance	C _{rss}			300		
Turn-On Time	t _{d(on)}	V _{DD} =15V, R _L =0.3Ω I _D ≒40A, V _{GEN} =10V R _G =2.5Ω		12	20	ns
	t _r			12	20	
Turn-Off Time	t _{d(off)}			30	45	
	t _f			10	20	



Typical Characteristics

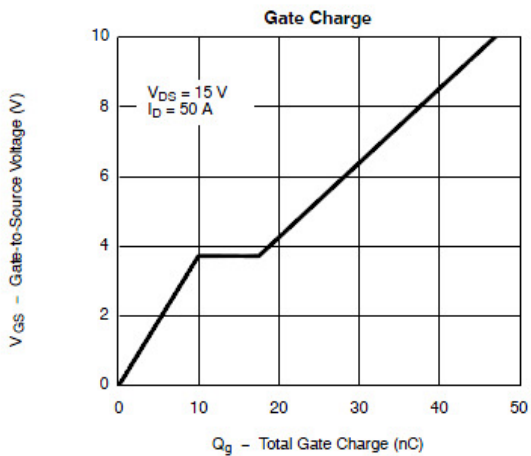
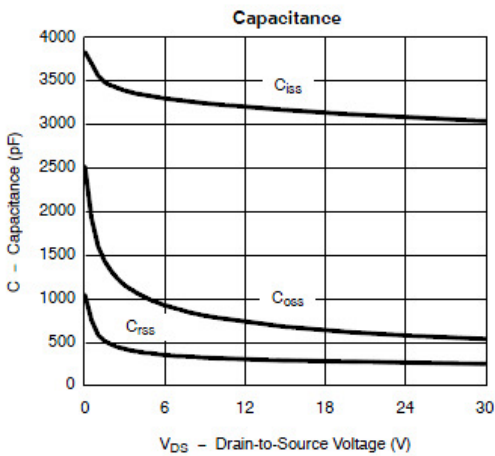
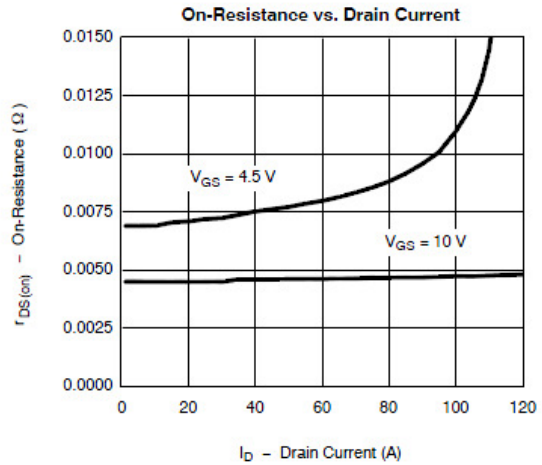
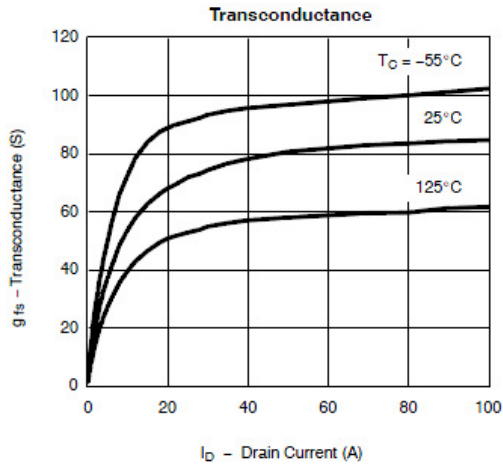
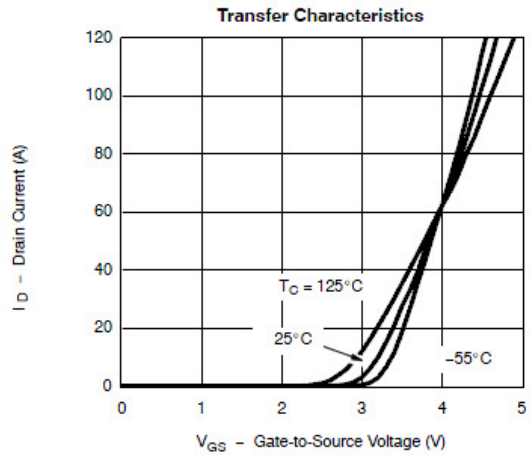
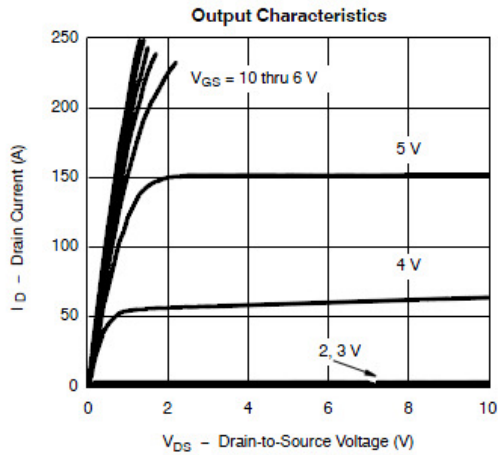



Typical Characteristics

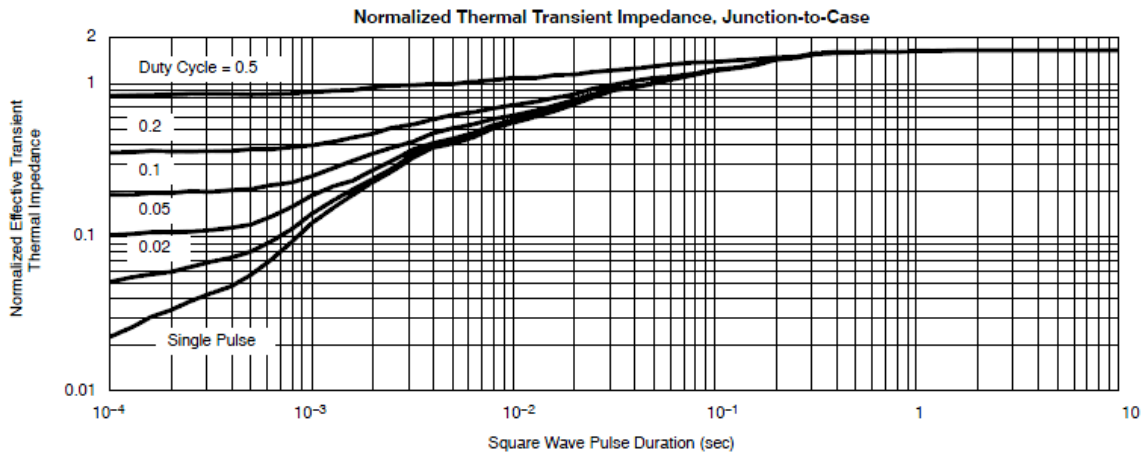
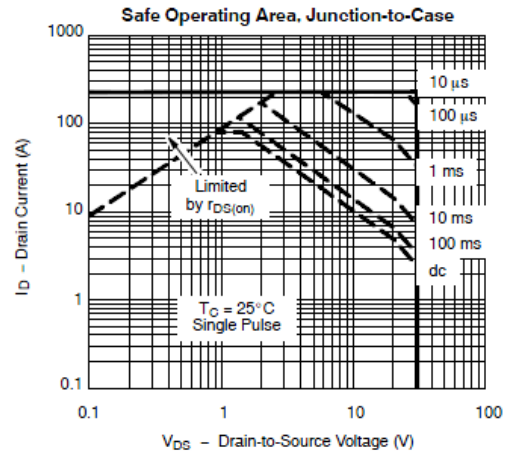
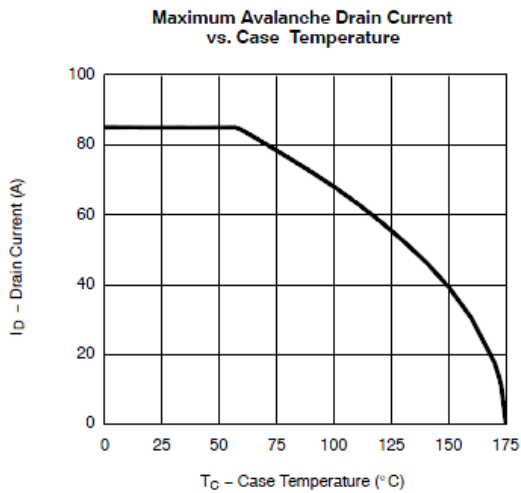
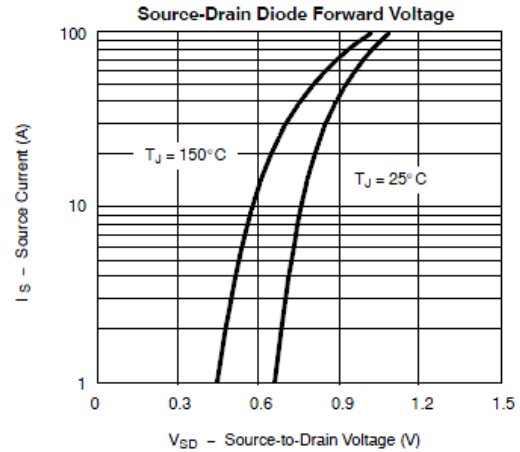
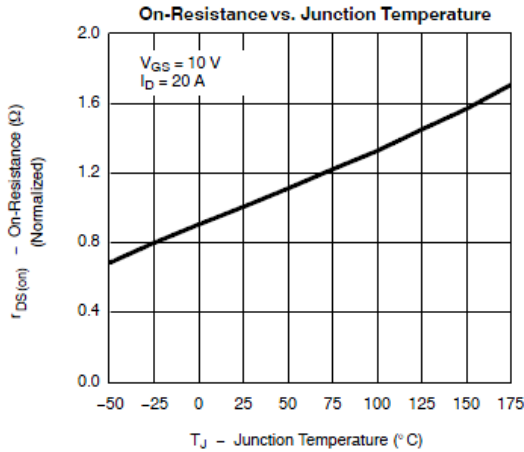



Typical Characteristics

Gate Charge Test Circuit & Waveform



Resistive Switching Test Circuit & Waveforms

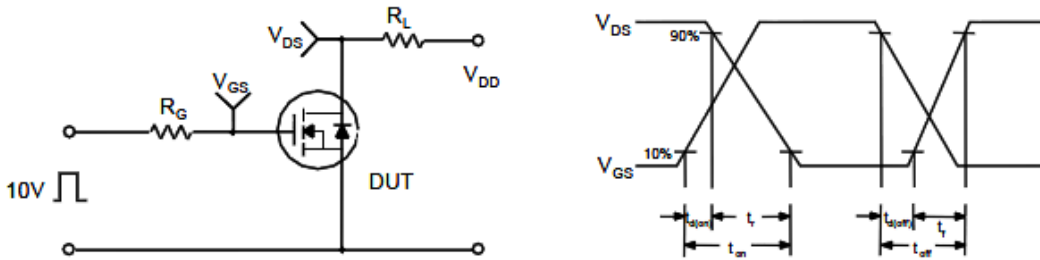

Unclamped Inductive Switching Test Circuit & Waveforms

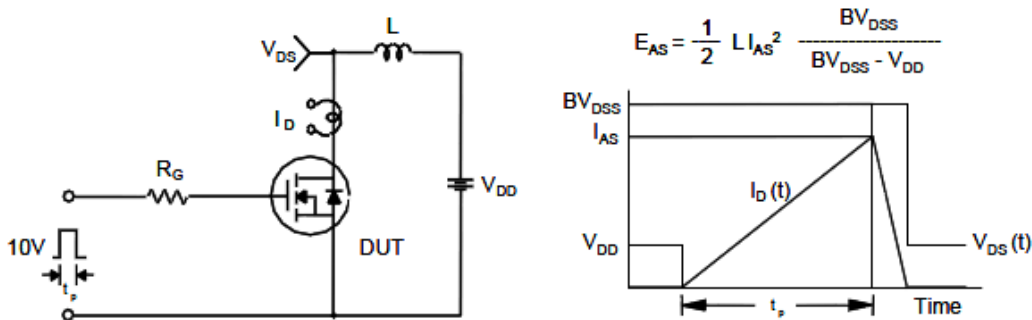



Package Information (TO-252-2L)

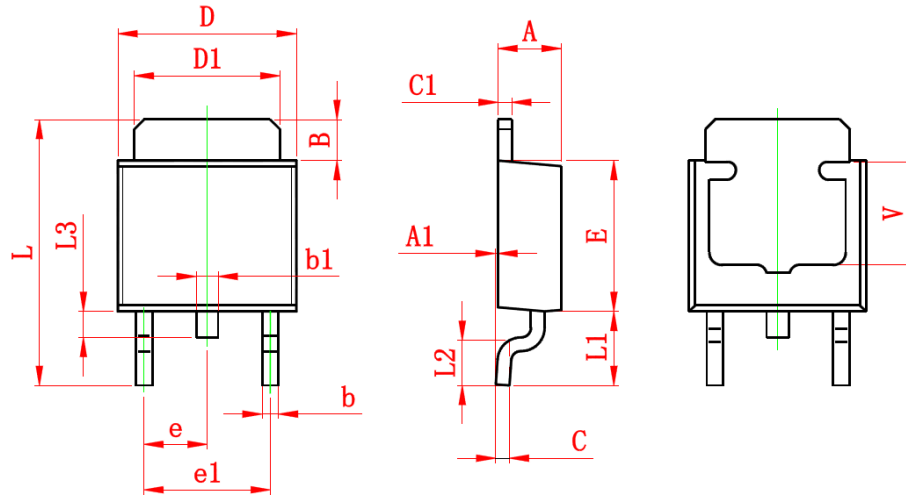

Symbol	Dimensions In Millimeters		Dimensions In Inches	
	Min.	Max.	Min.	Max.
A	2.200	2.400	0.087	0.094
A1	0.000	0.127	0.000	0.005
B	1.350	1.650	0.053	0.065
b	0.500	0.700	0.020	0.028
b1	0.700	0.900	0.028	0.035
c	0.430	0.580	0.017	0.023
c1	0.430	0.580	0.017	0.023
D	6.350	6.650	0.250	0.262
D1	5.200	5.400	0.205	0.213
E	5.400	5.700	0.213	0.224
e	2.300 TYP.		0.091 TYP.	
e1	4.500	4.700	0.177	0.185
L	9.500	9.900	0.374	0.390
L1	2.550	2.900	0.100	0.114
L2	1.400	1.780	0.055	0.070
L3	0.600	0.900	0.024	0.035
V	3.800 REF.		0.150 REF.	

©2010 Alfa-MOS Technology Corp.
2F, No.80, Sec.1, Cheng Kung Rd., Nan Kang Dist., Taipei City 115, Taiwan (R.O.C.)
Tel : 886 2) 2651 3928
Fax : 886 2) 2786 8483
©http://www.alfa-mos.com