



### General Description

AFN3400AS, N-Channel enhancement mode MOSFET, uses Advanced Trench Technology to provide excellent  $R_{DS(ON)}$ , low gate charge. These devices are particularly suited for low voltage power management, and low in-line power loss are needed in commercial industrial surface mount applications.

### Features

- 30V/4.0A,  $R_{DS(ON)}=30m\Omega@V_{GS}=10V$
- 30V/3.6A,  $R_{DS(ON)}=35m\Omega@V_{GS}=4.5V$
- 30V/2.8A,  $R_{DS(ON)}=40m\Omega@V_{GS}=2.5V$
- 30V/1.5A,  $R_{DS(ON)}=55m\Omega@V_{GS}=1.8V$
- Super high density cell design for extremely low  $R_{DS(ON)}$
- SOT-23 package design

### Pin Description ( SOT-23 )

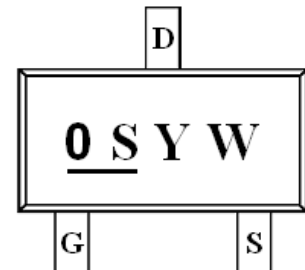
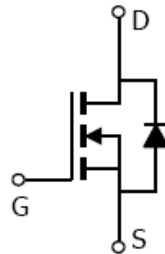
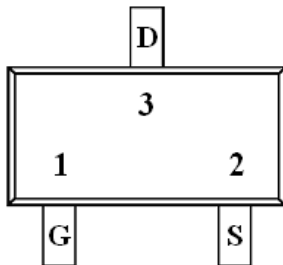

### Application

- Power Management in Note book
- LED Display
- DC-DC System
- LCD Panel

### Pin Define

Pin	Symbol	Description
1	G	Gate
2	S	Source
3	D	Drain

### Ordering Information

Part Ordering No.	Part Marking	Package	Unit	Quantity
AFN3400ASS23RG	0SYW	SOT-23	Tape & Reel	3000 EA

- ※ 0S parts code
- ※ Y year code ( 0 ~ 9 )
- ※ W week code ( A ~ Z = 1 ~ 26 / a ~ z = 27 ~ 52 )
- ※ AFN3400ASS23RG : 7" Tape & Reel ; Pb- Free ; Halogen- Free



### Absolute Maximum Ratings

( $T_A=25^\circ\text{C}$  Unless otherwise noted)

Parameter	Symbol	Value	Unit
Drain-Source Voltage	$V_{DSS}$	30	V
Gate –Source Voltage	$V_{GSS}$	$\pm 16$	V
Continuous Drain Current( $T_J=150^\circ\text{C}$ )	$I_D$	$T_A=25^\circ\text{C}$	4.0
		$T_A=70^\circ\text{C}$	2.2
Pulsed Drain Current	$I_{DM}$	15	A
Continuous Source Current(Diode Conduction)	$I_S$	1.7	A
Power Dissipation	$P_D$	$T_A=25^\circ\text{C}$	2.0
		$T_A=70^\circ\text{C}$	1.3
Operating Junction Temperature	$T_J$	150	$^\circ\text{C}$
Storage Temperature Range	$T_{STG}$	-55/150	$^\circ\text{C}$
Thermal Resistance-Junction to Ambient	$R_{\theta JA}$	120	$^\circ\text{C/W}$

### Electrical Characteristics

( $T_A=25^\circ\text{C}$  Unless otherwise noted)

Parameter	Symbol	Conditions	Min.	Typ	Max.	Unit
<b>Static</b>						
Drain-Source Breakdown Voltage	$V_{(BR)DSS}$	$V_{GS}=0V, I_D=250\mu\text{A}$	30			V
Gate Threshold Voltage	$V_{GS(th)}$	$V_{DS}=V_{GS}, I_D=250\mu\text{A}$	0.6		1.1	
Gate Leakage Current	$I_{GSS}$	$V_{DS}=0V, V_{GS}=\pm 16V$			$\pm 100$	nA
Zero Gate Voltage Drain Current	$I_{DSS}$	$V_{DS}=24V, V_{GS}=0V$			1	uA
		$V_{DS}=24V, V_{GS}=0V$ $T_J=85^\circ\text{C}$			30	
On-State Drain Current	$I_{D(on)}$	$V_{DS} \geq 5V, V_{GS}=4.5V$	30			A
Drain-Source On-Resistance	$R_{DS(on)}$	$V_{GS}=10V, I_D=4.0A$		23	30	m $\Omega$
		$V_{GS}=4.5V, I_D=3.6A$		25	35	
		$V_{GS}=2.5V, I_D=2.8A$		30	40	
		$V_{GS}=1.8V, I_D=1.5A$		40	55	
Forward Transconductance	$g_{FS}$	$V_{DS}=10V, I_D=6.1A$		20		S
Diode Forward Voltage	$V_{SD}$	$I_S=1.7A, V_{GS}=0V$		0.8	1.2	V
<b>Dynamic</b>						
Total Gate Charge	$Q_g$	$V_{DS}=15V, V_{GS}=10V$ $I_D \equiv 2.6A$		3.0	4.5	nC
Gate-Source Charge	$Q_{gs}$			1.6		
Gate-Drain Charge	$Q_{gd}$			0.6		
Input Capacitance	$C_{iss}$	$V_{DS}=15V, V_{GS}=0V$ $f=1\text{MHz}$		320		pF
Output Capacitance	$C_{oss}$			70		
Reverse Transfer Capacitance	$C_{rss}$			30		
Turn-On Time	$t_{d(on)}$	$V_{DD}=15V, R_L=15\Omega$ $I_D \equiv 1.0A, V_{GEN}=10V$ $R_G=6\Omega$		8	12	ns
	$t_r$			12	18	
Turn-Off Time	$t_{d(off)}$			15	30	
	$t_f$			8	15	



## Typical Characteristics

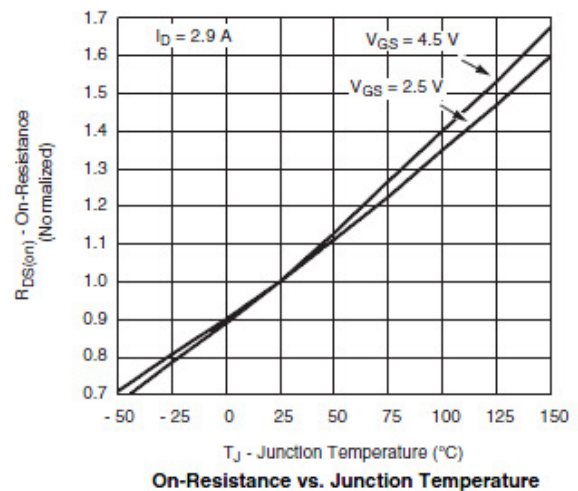
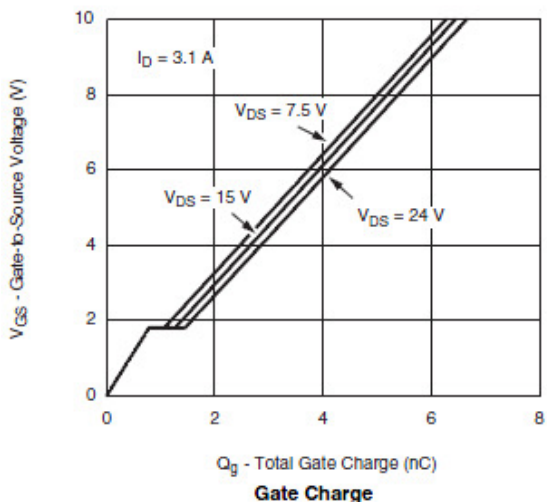
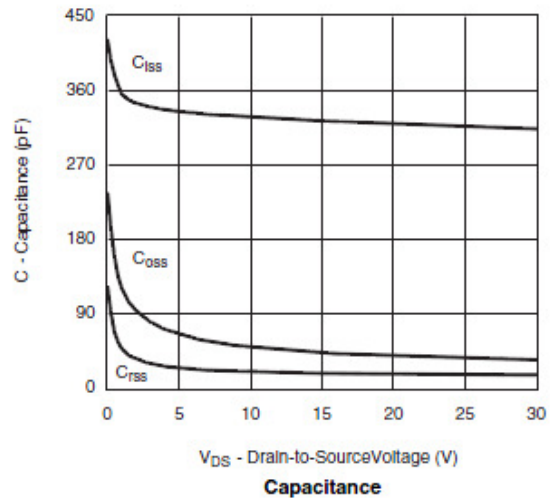
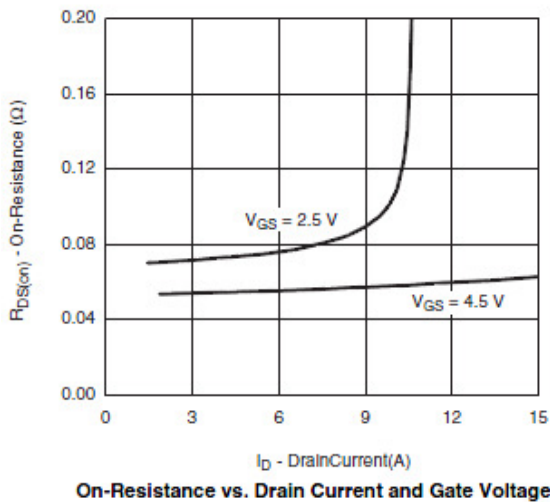
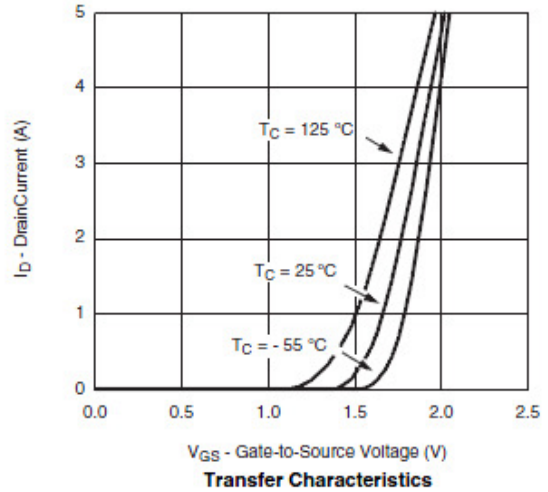
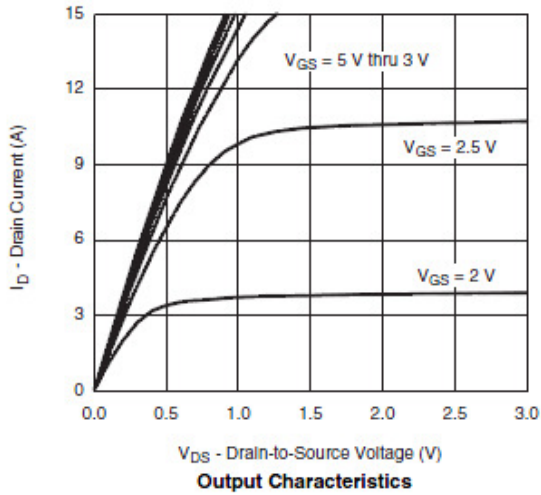



## Typical Characteristics

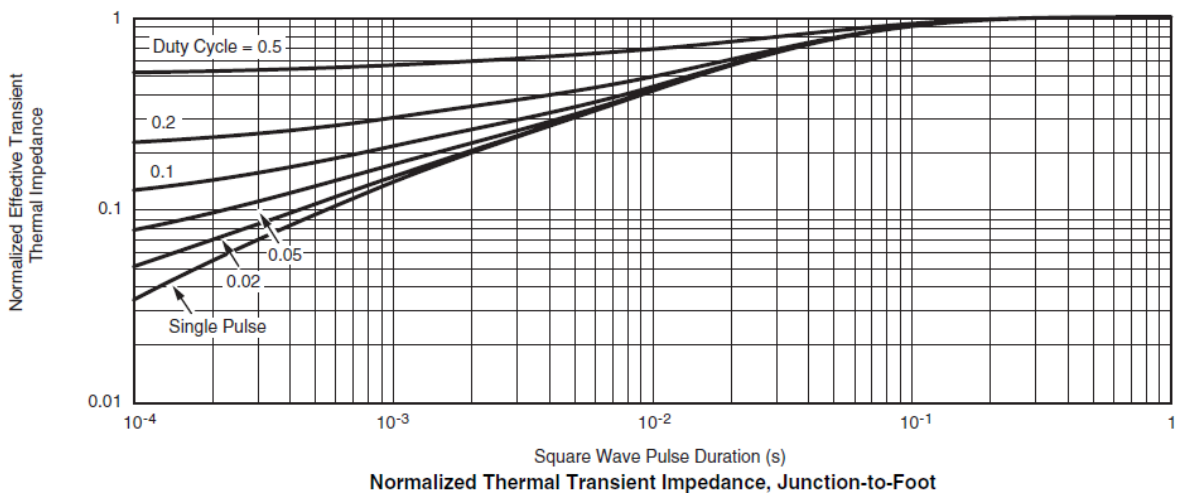
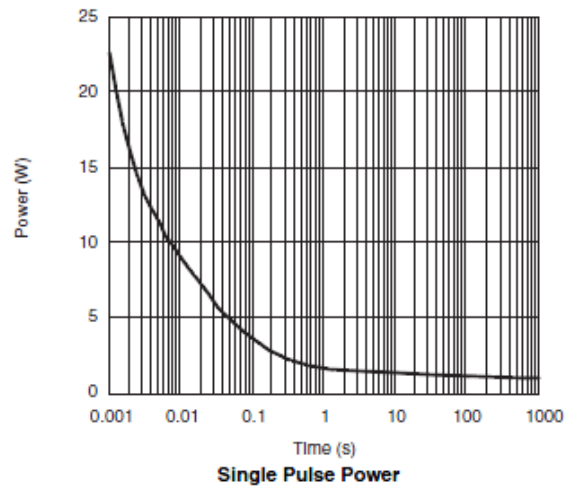
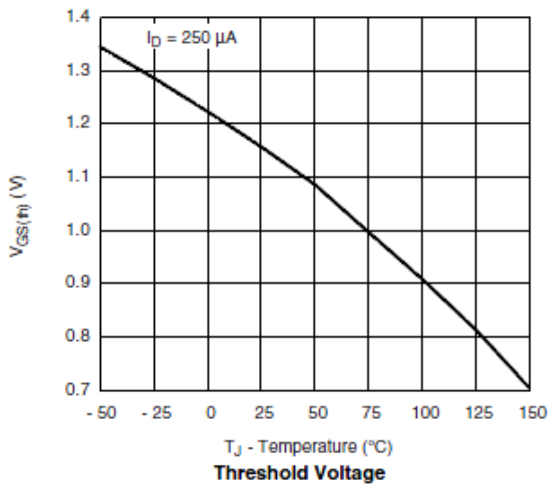
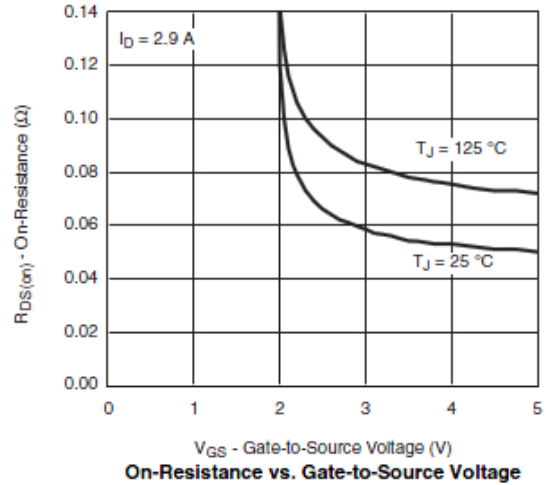
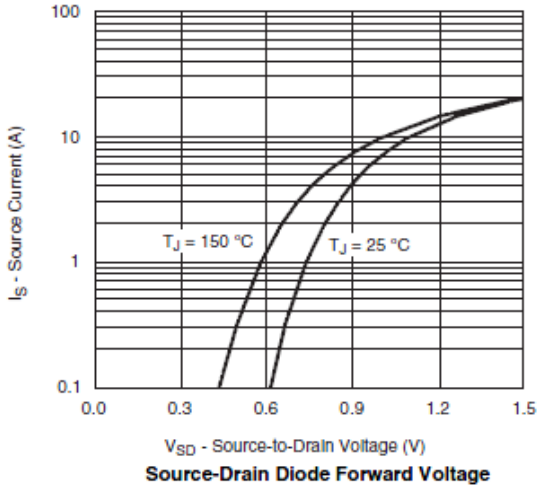



**Typical Characteristics**

Gate Charge Test Circuit & Waveform



Resistive Switching Test Circuit & Waveforms



Unclamped Inductive Switching Test Circuit & Waveforms





**Package Information ( SOT-23 )**

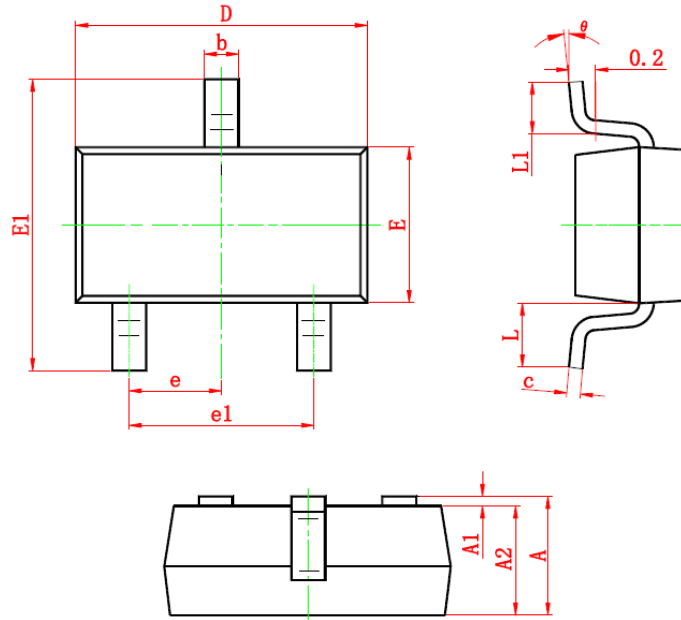

Symbol	Dimensions In Millimeters		Dimensions In Inches	
	Min	Max	Min	Max
A	0.900	1.200	0.035	0.043
A1	0.000	0.100	0.000	0.004
A2	0.900	1.100	0.035	0.039
b	0.300	0.500	0.012	0.020
c	0.080	0.150	0.003	0.006
D	2.800	3.000	0.110	0.118
E	1.200	1.400	0.047	0.055
E1	2.250	2.550	0.089	0.100
e	0.950 TYP		0.037 TYP	
e1	1.800	2.000	0.071	0.079
L	0.550 REF		0.022 REF	
L1	0.300	0.500	0.012	0.020
θ	0°	8°	0°	6°

©2010 Alfa-MOS Technology Corp.  
 2F, No.80, Sec.1, Cheng Kung Rd., Nan Kang Dist., Taipei City 115, Taiwan (R.O.C.)  
 Tel : 886 2) 2651 3928  
 Fax : 886 2) 2786 8483  
 ©http://www.alfa-mos.com