



General Description

AFN3484S, N-Channel enhancement mode MOSFET, uses Advanced Trench Technology to provide excellent $R_{DS(ON)}$, low gate charge. These devices are particularly suited for low voltage power management, and low in-line power loss are needed in commercial industrial surface mount applications.

Features

- 30V/30A, $R_{DS(ON)}=13m\Omega@V_{GS}=10V$
- 30V/18A, $R_{DS(ON)}=18m\Omega@V_{GS}=4.5V$
- Super high density cell design for extremely low $R_{DS(ON)}$
- TO-252-2L package design

Pin Description (TO-252-2L)

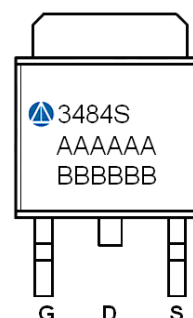
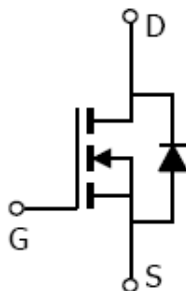
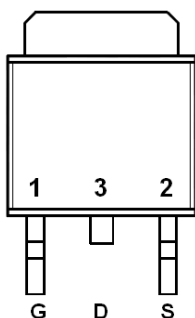

Application

- Buck Converter
 - Low Side
- Synchronous Rectifier
 - Secondary Rectifier

Pin Define

Pin	Symbol	Description
1	G	Gate
2	S	Source
3	D	Drain

Ordering Information

Part Ordering No.	Part Marking	Package	Unit	Quantity
AFN3484ST252RG	3484S	TO-252-2L	Tape & Reel	2500 EA

- ※ A Lot code
- ※ B Date code
- ※ AFN3484ST252RG : 13" Tape & Reel ; Pb- Free ; Halogen -Free



Absolute Maximum Ratings

($T_A=25^\circ\text{C}$ Unless otherwise noted)

Parameter	Symbol	Value	Unit
Drain-Source Voltage	V_{DS}	30	V
Gate-Source Voltage	V_{GS}	± 20	V
Continuous Drain Current($T_J=150^\circ\text{C}$)	I_D	$T_A=25^\circ\text{C}$	30
		$T_A=70^\circ\text{C}$	18
Pulsed Drain Current	I_{DM}	40	A
Continuous Source Current(Diode Conduction)	I_S	9.0	A
Power Dissipation	P_D	$T_A=25^\circ\text{C}$	40
		$T_A=70^\circ\text{C}$	15
Operating Junction Temperature	T_J	150	$^\circ\text{C}$
Storage Temperature Range	T_{STG}	-55/150	$^\circ\text{C}$
Thermal Resistance-Junction to Ambient	$R_{\theta JA}$	62.5	$^\circ\text{C/W}$

Electrical Characteristics

($T_A=25^\circ\text{C}$ Unless otherwise noted)

Parameter	Symbol	Conditions	Min.	Typ	Max.	Unit
Static						
Drain-Source Breakdown Voltage	$V_{(BR)DS}$	$V_{GS}=0V, I_D=250\mu\text{A}$	30			V
Gate Threshold Voltage	$V_{GS(th)}$	$V_{DS}=V_{GS}, I_D=250\mu\text{A}$	1.0		2.0	
Gate Leakage Current	I_{GSS}	$V_{DS}=0V, V_{GS}=\pm 20V$			± 100	nA
Zero Gate Voltage Drain Current	I_{DSS}	$V_{DS}=24V, V_{GS}=0V$			1	uA
		$V_{DS}=24V, V_{GS}=0V$ $T_J=85^\circ\text{C}$			10	
On-State Drain Current	$I_{D(on)}$	$V_{DS} \geq 5V, V_{GS}=10V$	15			A
Drain-Source On-Resistance	$R_{DS(on)}$	$V_{GS}=10V, I_D=12A$		10	13	m Ω
		$V_{GS}=4.5V, I_D=10A$		14	18	
Forward Transconductance	g_{FS}	$V_{DS}=15V, I_D=10A$		24		S
Diode Forward Voltage	V_{SD}	$I_S=12A, V_{GS}=0V$		0.8	1.3	V
Dynamic						
Total Gate Charge	Q_g	$V_{DS}=15V, V_{GS}=4.5V$ $I_D \equiv 10A$		8	13	nC
Gate-Source Charge	Q_{gs}			3.7		
Gate-Drain Charge	Q_{gd}			2.7		
Input Capacitance	C_{iss}	$V_{DS}=15V, V_{GS}=0V$ $f=1\text{MHz}$		950		pF
Output Capacitance	C_{oss}			200		
Reverse Transfer Capacitance	C_{rss}			85		
Turn-On Time	$t_{d(on)}$	$V_{DD}=15V, R_L=1.5\Omega$ $I_D \equiv 10A, V_{GEN}=10V$ $R_G=1\Omega$		10	20	ns
	t_r			10	20	
Turn-Off Time	$t_{d(off)}$			20	35	
	t_f			10	20	



Typical Characteristics

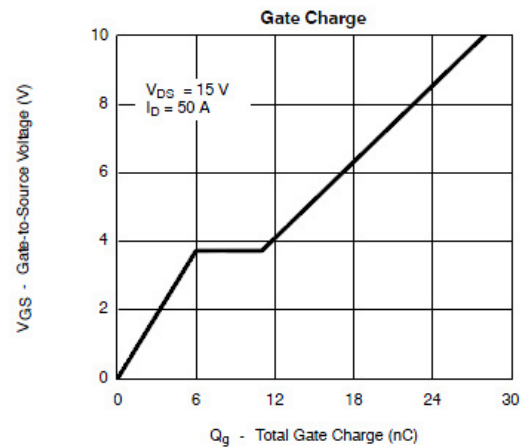
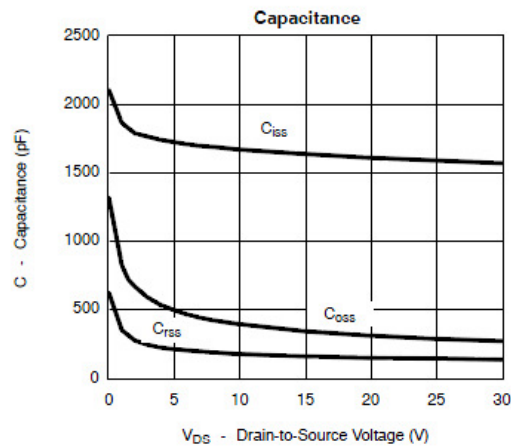
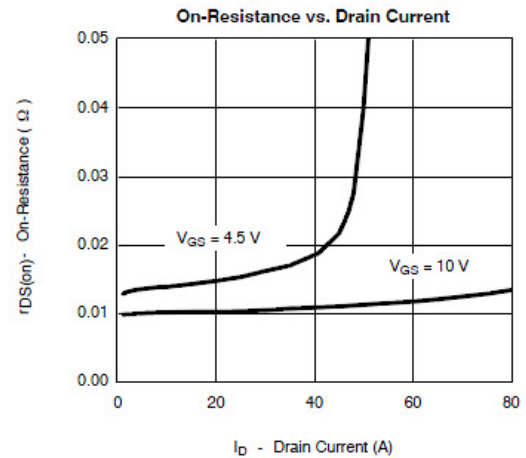
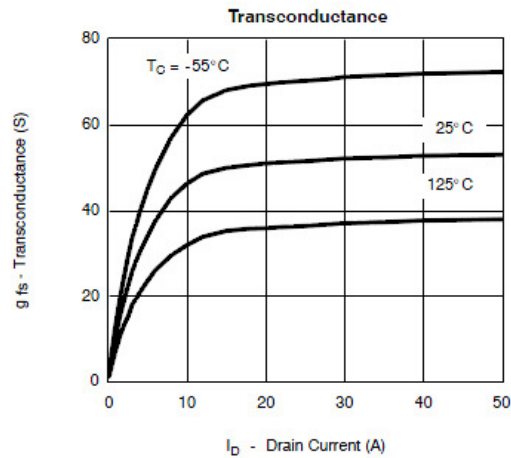
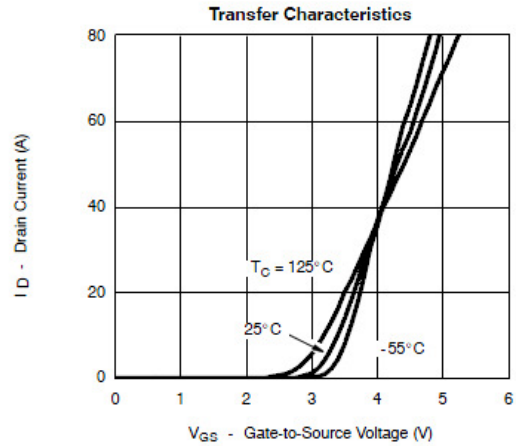
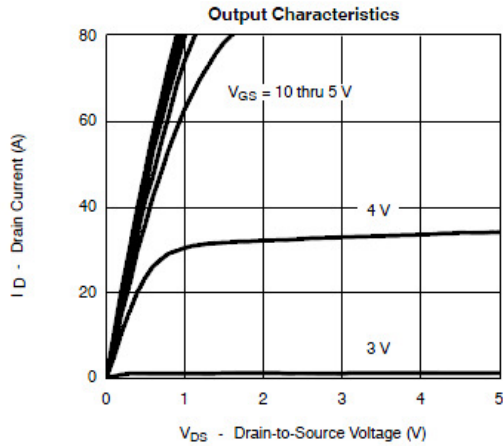



Typical Characteristics

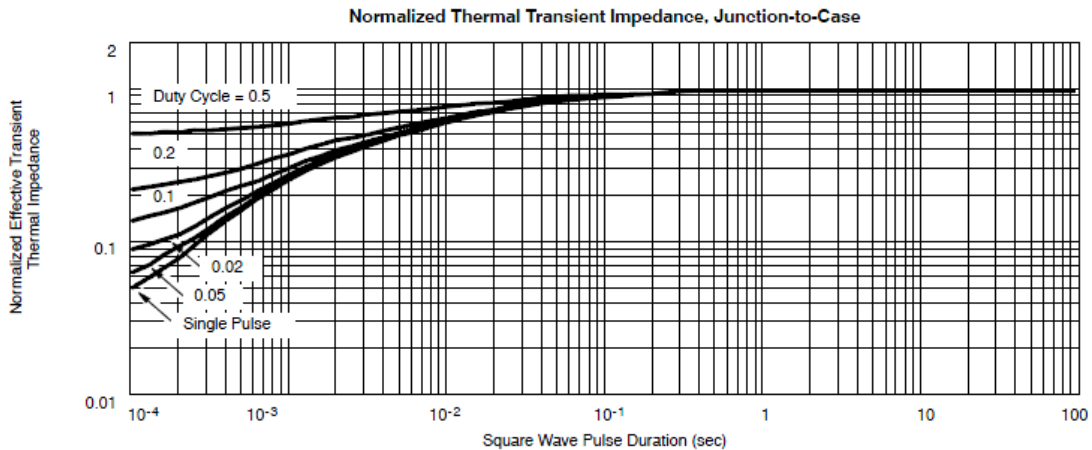
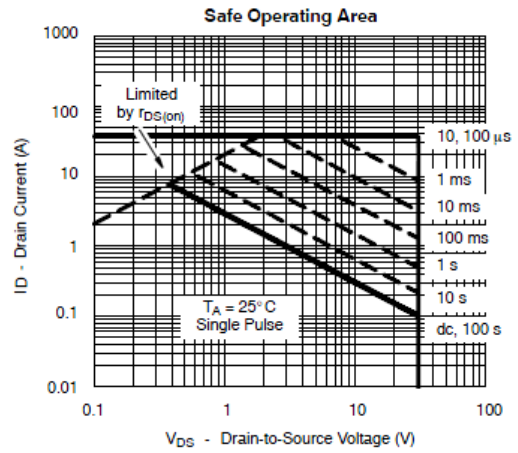
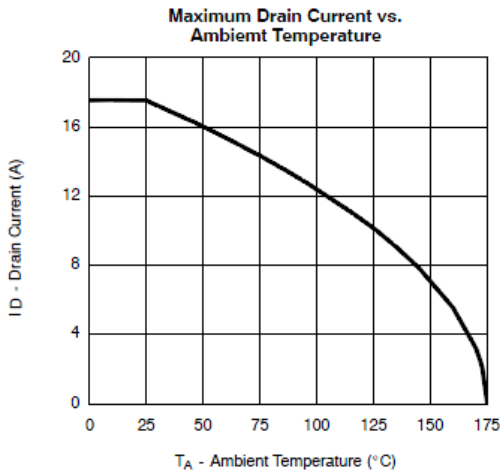
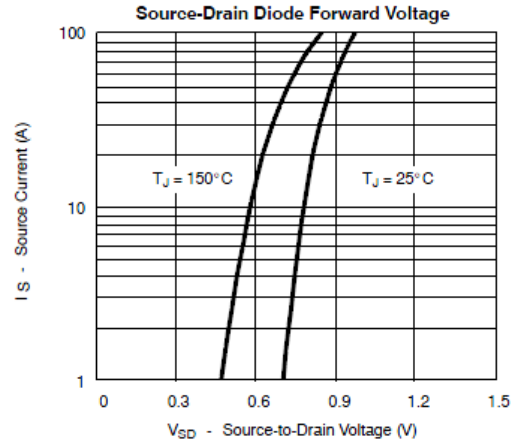
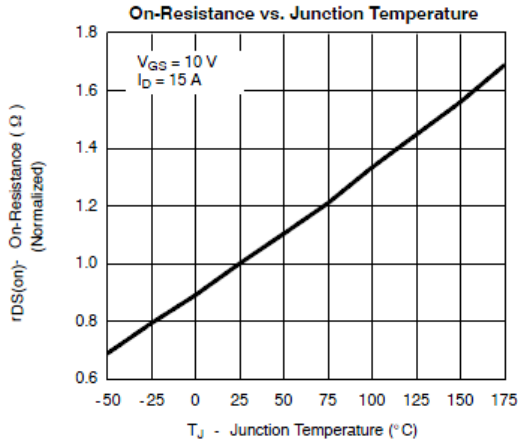



Typical Characteristics

Gate Charge Test Circuit & Waveform

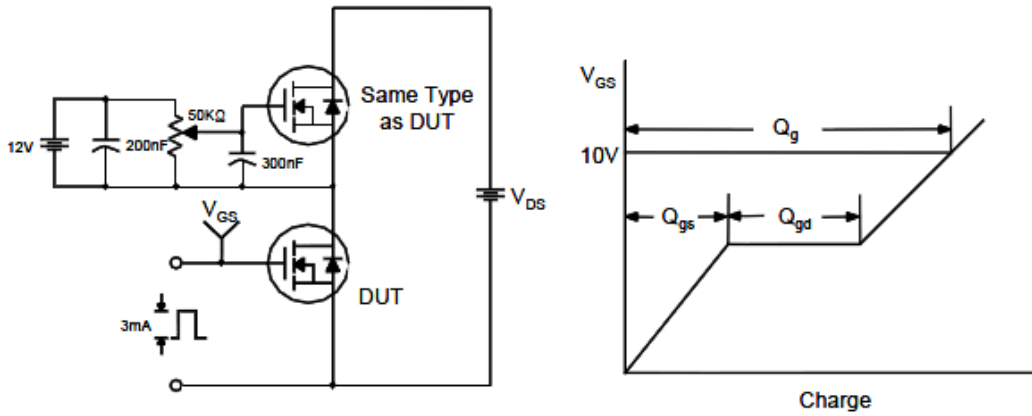

Resistive Switching Test Circuit & Waveforms

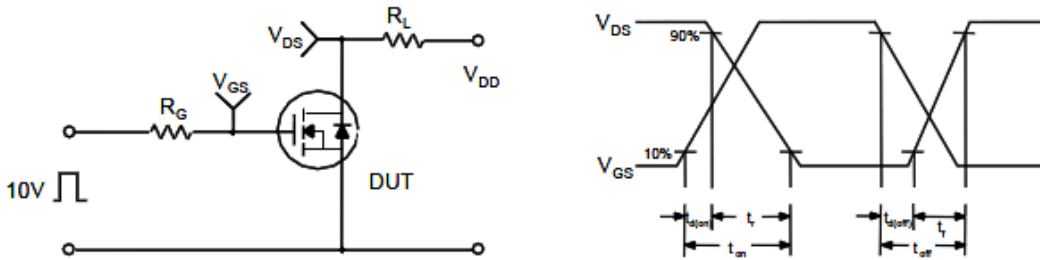

Unclamped Inductive Switching Test Circuit & Waveforms

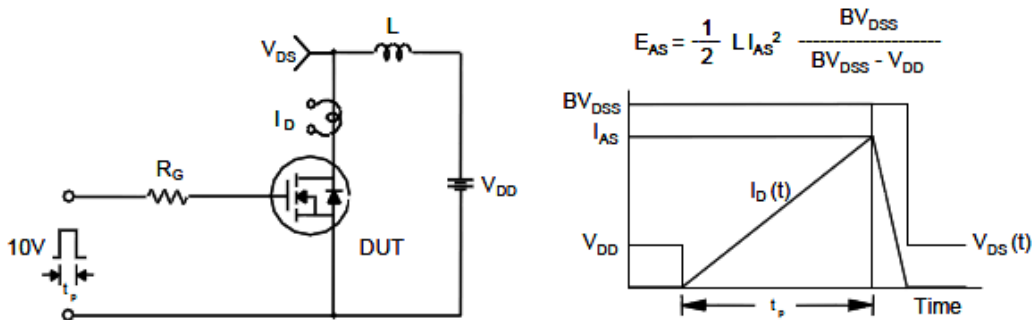



Package Information (TO-252-2L)

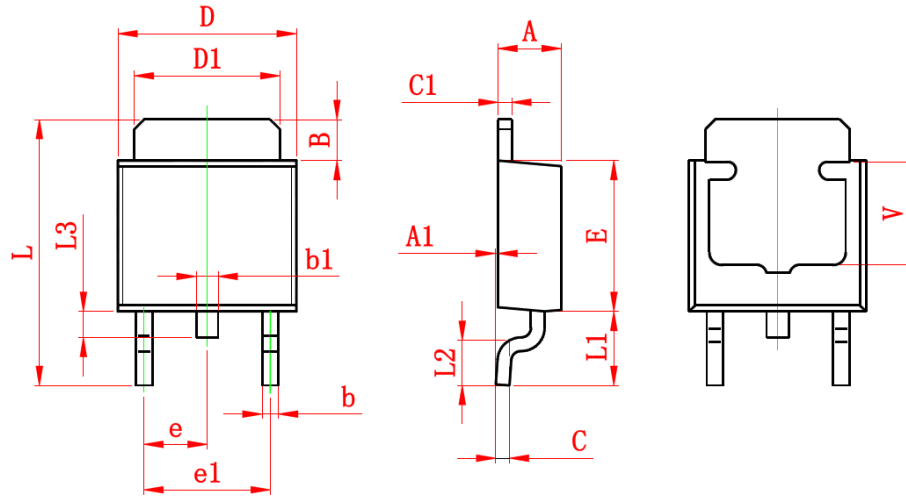

Symbol	Dimensions In Millimeters		Dimensions In Inches	
	Min.	Max.	Min.	Max.
A	2.200	2.400	0.087	0.094
A1	0.000	0.127	0.000	0.005
B	1.350	1.650	0.053	0.065
b	0.500	0.700	0.020	0.028
b1	0.700	0.900	0.028	0.035
c	0.430	0.580	0.017	0.023
c1	0.430	0.580	0.017	0.023
D	6.350	6.650	0.250	0.262
D1	5.200	5.400	0.205	0.213
E	5.400	5.700	0.213	0.224
e	2.300 TYP.		0.091 TYP.	
e1	4.500	4.700	0.177	0.185
L	9.500	9.900	0.374	0.390
L1	2.550	2.900	0.100	0.114
L2	1.400	1.780	0.055	0.070
L3	0.600	0.900	0.024	0.035
V	3.800 REF.		0.150 REF.	

©2010 Alfa-MOS Technology Corp.
 2F., No.80, Sec. 1, Chenggong Rd., Nangang Dist., Taipei City 115, Taiwan (R.O.C.)
 Tel : 886 2) 2651 3928
 Fax : 886 2) 2786 8483
 ©http://www.alfa-mos.com