



General Description

AFN6562, N-Channel enhancement mode MOSFET, uses Advanced Trench Technology to provide excellent $R_{DS(ON)}$, low gate charge. These devices are particularly suited for low voltage power management, and low in-line power loss are needed in commercial industrial surface mount applications.

Features

- 30V/3.6A, $R_{DS(ON)}=70m\Omega@V_{GS}=10V$
- 30V/3.0A, $R_{DS(ON)}=78m\Omega@V_{GS}=4.5V$
- 30V/2.2A, $R_{DS(ON)}=145m\Omega@V_{GS}=2.5V$
- Super high density cell design for extremely low $R_{DS(ON)}$
- TSOP-6 package design

Pin Description (TSOP-6)

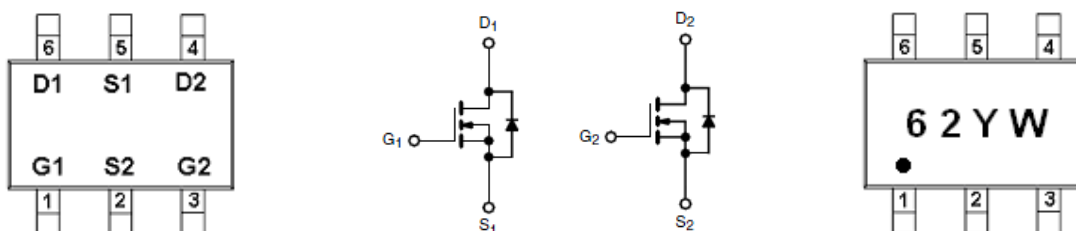

Application

- Power Management in Note book
- LED Display
- DC-DC System
- LCD Panel

PPin Define

Pin	Symbol	Description
1	G1	Gate 1
2	S2	Source 2
3	G2	Gate 2
4	D2	Drain 2
5	S1	Source 1
6	D1	Drain1

Ordering Information

Part Ordering No.	Part Marking	Package	Unit	Quantity
AFN6562TS6RG	62YW	TSOP-6	Tape & Reel	3000 EA

- ※ 62 parts code
- ※ Y year code (0 ~ 9)
- ※ W week code (A ~ Z = 1 ~ 26 / a ~ z = 27 ~ 52)
- ※ AFN6562TS6RG : 7" Tape & Reel ; Pb- Free ; Halogen -Free



Absolute Maximum Ratings

(T_A=25°C Unless otherwise noted)

Parameter	Symbol	Value	Unit
Drain-Source Voltage	V _{DSS}	30	V
Gate-Source Voltage	V _{GSS}	±12	V
Continuous Drain Current(T _J =150°C)	I _D	T _A =25°C	3.6
		T _A =70°C	2.2
Pulsed Drain Current	I _{DM}	20	A
Continuous Source Current(Diode Conduction)	I _S	1.7	A
Power Dissipation	P _D	T _A =25°C	2.0
		T _A =70°C	1.3
Operating Junction Temperature	T _J	150	°C
Storage Temperature Range	T _{STG}	-55/150	°C
Thermal Resistance-Junction to Ambient	R _{θJA}	120	°C/W

Electrical Characteristics

(T_A=25°C Unless otherwise noted)

Parameter	Symbol	Conditions	Min.	Typ	Max.	Unit
Static						
Drain-Source Breakdown Voltage	V _{(BR)DSS}	V _{GS} =0V, I _D =250μA	30			V
Gate Threshold Voltage	V _{GS(th)}	V _{DS} =V _{GS} , I _D =250μA	0.4		1.2	
Gate Leakage Current	I _{GSS}	V _{DS} =0V, V _{GS} =±12V			±100	nA
Zero Gate Voltage Drain Current	I _{DSS}	V _{DS} =24V, V _{GS} =0V			1	μA
		V _{DS} =24V, V _{GS} =0V T _J =85°C			30	
On-State Drain Current	I _{D(on)}	V _{DS} ≥ 5V, V _{GS} =4.5V	30			A
Drain-Source On-Resistance	R _{DS(on)}	V _{GS} =10V, I _D =3.6A		56	70	mΩ
		V _{GS} =4.5V, I _D =3.0A		62	78	
		V _{GS} =2.5V, I _D =2.2A		110	145	
Forward Transconductance	g _{FS}	V _{DS} =10V, I _D =1.6A		20		S
Diode Forward Voltage	V _{SD}	I _S =1.7A, V _{GS} =0V		0.8	1.2	V
Dynamic						
Total Gate Charge	Q _g	V _{DS} =15V, V _{GS} =4.5V I _D ≅3.6A		2.3	3	nC
Gate-Source Charge	Q _{gs}			1.0		
Gate-Drain Charge	Q _{gd}			0.6		
Input Capacitance	C _{iss}	V _{DS} =15V, V _{GS} =0V f=1MHz		280		pF
Output Capacitance	C _{oss}			40		
Reverse Transfer Capacitance	C _{rss}			20		
Turn-On Time	t _{d(on)}	V _{DD} =15V, R _L =15Ω I _D ≅1.0A, V _{GEN} =10V R _G =6Ω		10	15	ns
	t _r			12	20	
Turn-Off Time	t _{d(off)}			15	25	
	t _f			10	15	



Typical Characteristics

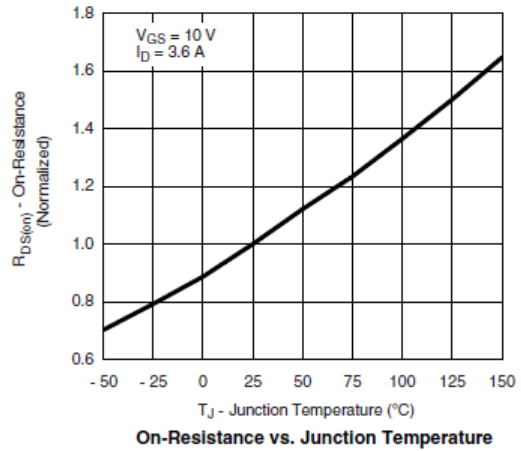
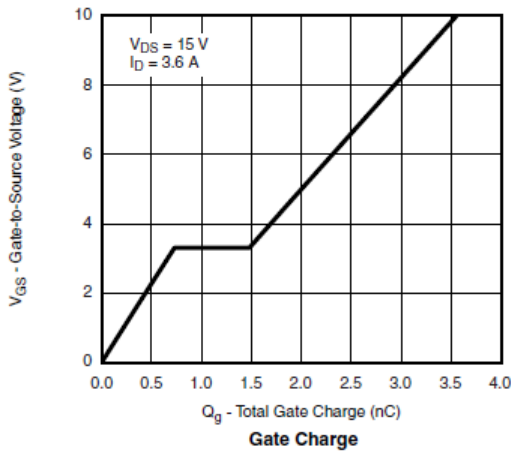
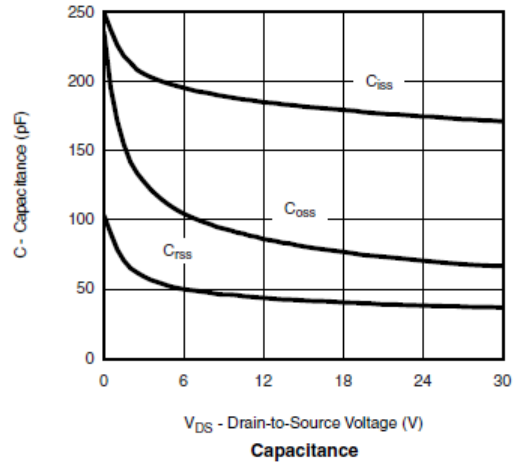
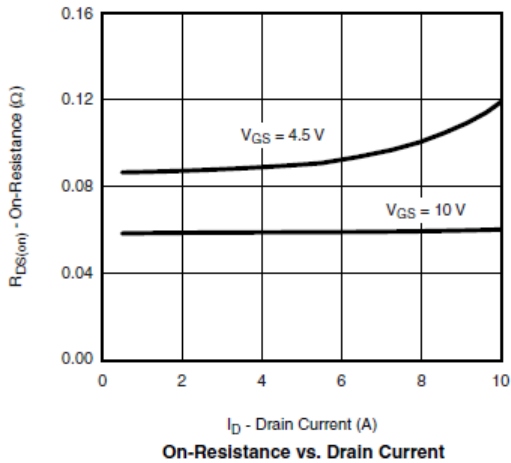
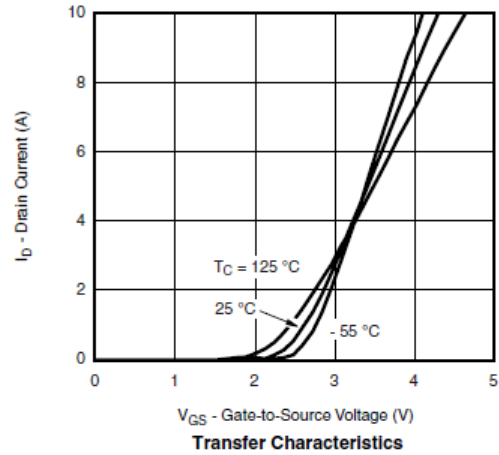
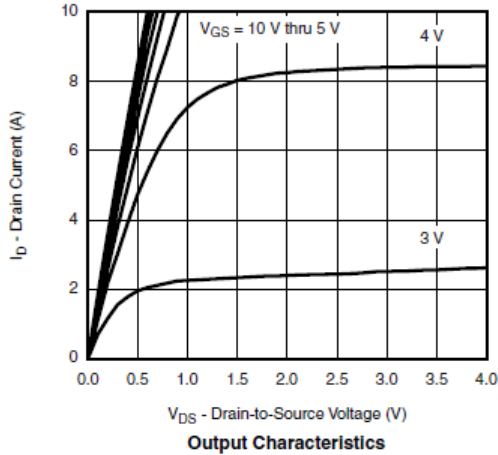



Typical Characteristics

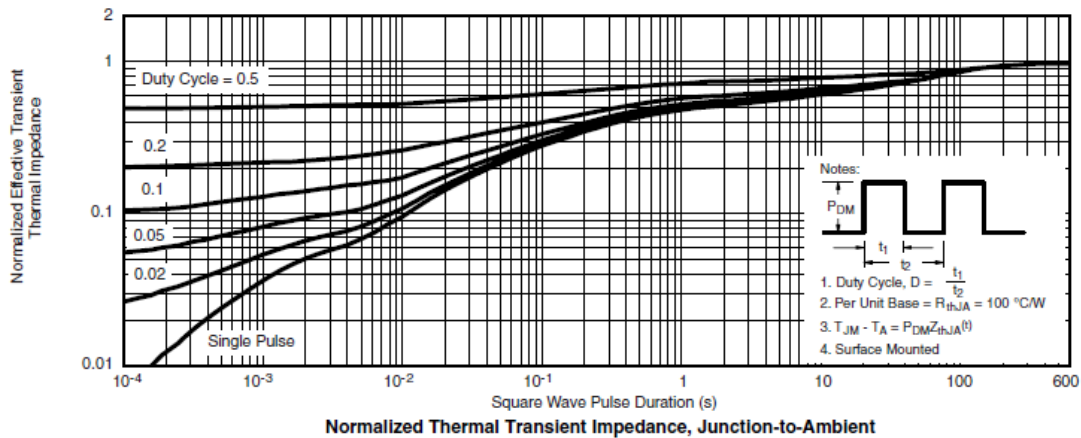
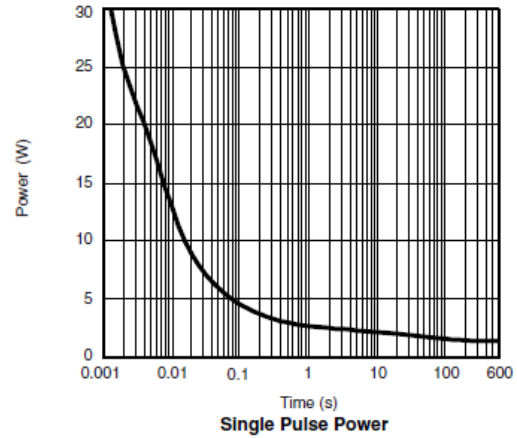
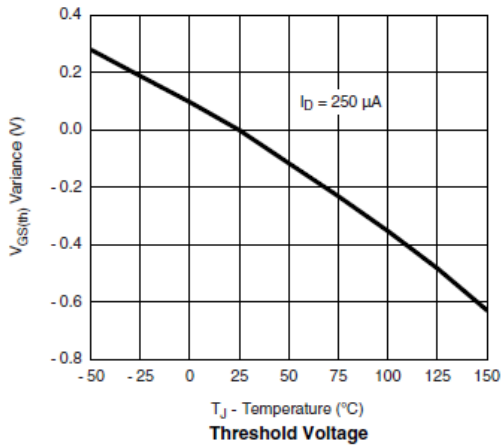
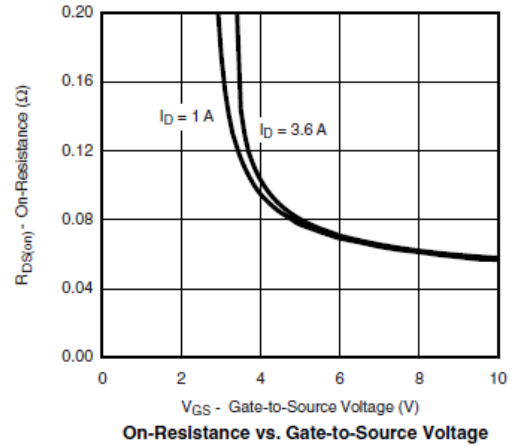
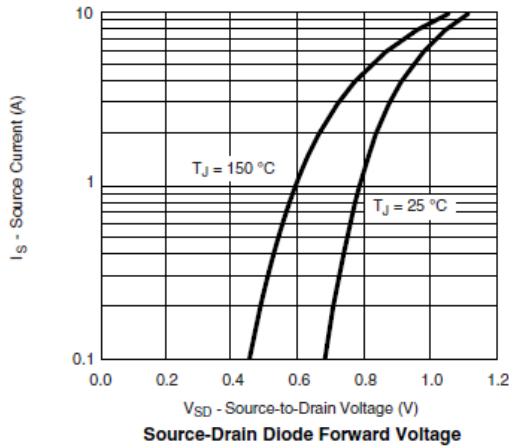



Typical Characteristics

Gate Charge Test Circuit & Waveform



Resistive Switching Test Circuit & Waveforms

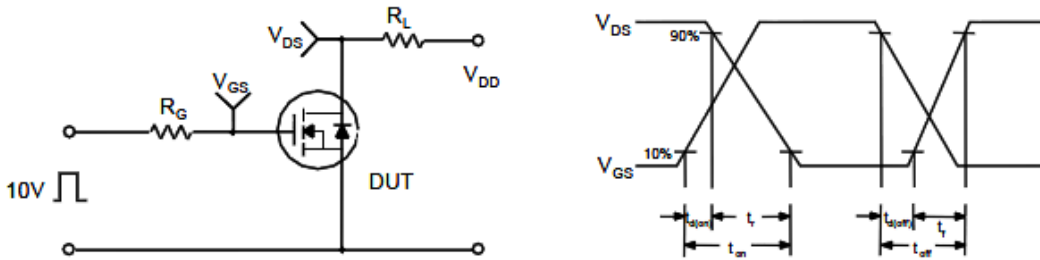

Unclamped Inductive Switching Test Circuit & Waveforms

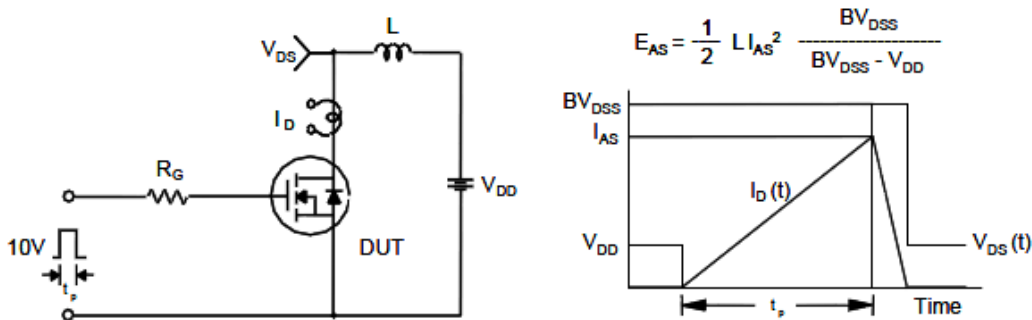



Package Information (TSOP-6)

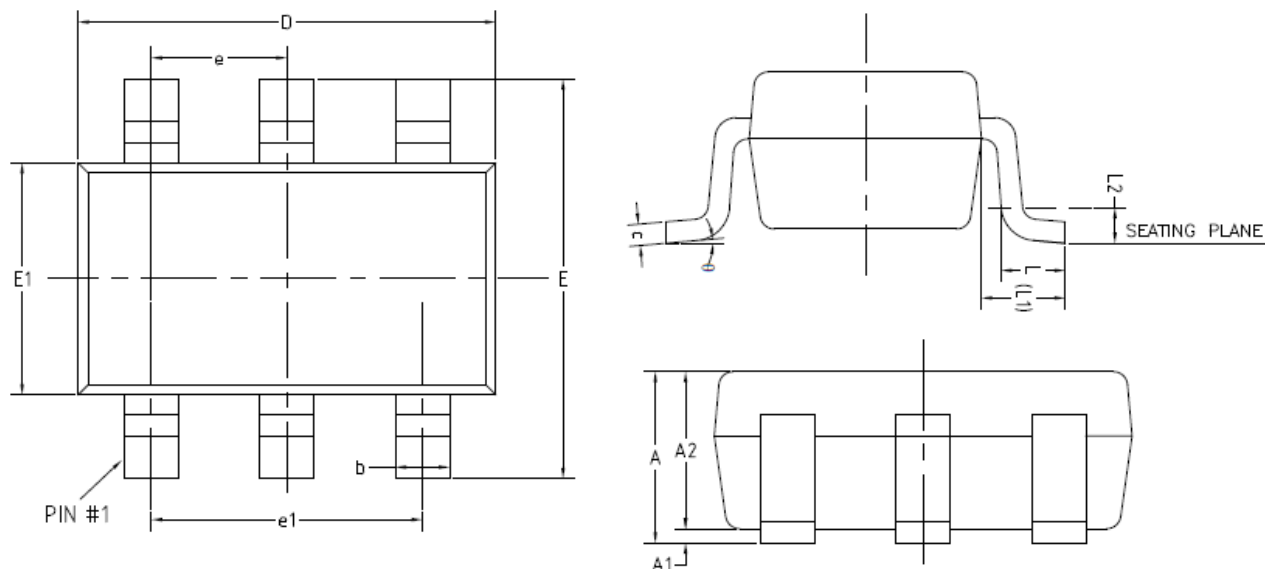

COMMON DIMENSIONS
(UNITS OF MEASURE=MILLIMETER)

SYMBOL	MIN	NOM	MAX
A	0.70	-	0.90
A1	0	-	0.10
A2	0.70	0.75	0.80
b	0.35	-	0.50
c	0.08	-	0.20
D	2.82	2.92	3.02
E	2.65	2.80	2.95
E1	1.60	1.65	1.70
e	0.95(BSC)		
e1	1.90(BSC)		
L	0.30	0.45	0.60
L1	0.59REF		
L2	0.25BSC		
θ	0°	-	8°

©2010 Alfa-MOS Technology Corp.
 2F, No.80, Sec.1, Cheng Kung Rd., Nan Kang Dist., Taipei City 115, Taiwan (R.O.C.)
 Tel : 886 2) 2651 3928
 Fax : 886 2) 2786 8483
 ©http://www.alfa-mos.com