



### General Description

AFN6826S, N-Channel enhancement mode MOSFET, uses Advanced Trench Technology to provide excellent  $R_{DS(ON)}$ , low gate charge.

These devices are particularly suited for low voltage power management, and low in-line power loss are needed in commercial industrial surface mount applications.

### Features

- 80V/20A,  $R_{DS(ON)}=5.0m\Omega@V_{GS}=10V$
- 80V/15A,  $R_{DS(ON)}=6.5m\Omega@V_{GS}=4.5V$
- Super high density cell design for extremely low  $R_{DS(ON)}$
- DFN5X6-8L package design

### Pin Description ( DFN5X6-8L )

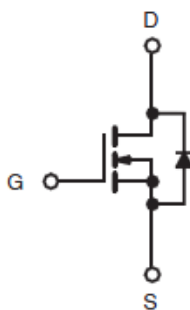
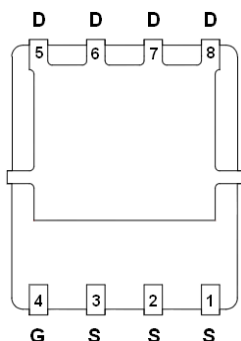

### Application

- Networking / Telecom / Server
- LED Lighting Applications
- Quick Charger Applications
- DC-DC Primary Side Switch

### Pin Define

Pin	Symbol	Description
1~3	S	Source
4	G	Gate
5~8	D	Drain

### Ordering Information

Part Ordering No.	Part Marking	Package	Unit	Quantity
AFN6826SFN568RG	6826S	DFN5X6-8L	Tape & Reel	2500 EA

- ※ A Lot code
- ※ B Date code
- ※ AFN6826SFN568RG : 13" Tape & Reel ; Pb- Free ; Halogen- Free



**Absolute Maximum Ratings**

(T<sub>A</sub>=25°C Unless otherwise noted)

Parameter	Symbol	Typical	Unit
Drain-Source Voltage	V <sub>DSS</sub>	80	V
Gate –Source Voltage	V <sub>GSS</sub>	±20	V
Continuous Drain Current(T <sub>J</sub> =150°C)	I <sub>DSM</sub>	T <sub>C</sub> =25°C	60
		T <sub>C</sub> =70°C	60
Pulsed Drain Current ( t=100us)	I <sub>DM</sub>	T <sub>A</sub> =25°C	24
		T <sub>A</sub> =70°C	20
Continuous Source Current(Diode Conduction)	I <sub>S</sub>	60	A
Single Pulse Avalanche Current	E <sub>AS</sub>	T <sub>C</sub> =25°C	35
		T <sub>A</sub> =25°C	60
Power Dissipation	P <sub>D</sub>	L=0.1mH	100
		T <sub>C</sub> =25°C	65
Operating Junction Temperature	T <sub>J</sub>	T <sub>C</sub> =75°C	6.2
		T <sub>A</sub> =75°C	4.0
Storage Temperature Range	T <sub>STG</sub>	-55/150	°C
Thermal Resistance-Junction to Ambient	R <sub>θJA</sub>	15	°C/W
Maximum Junction-to-Case (Drain)	R <sub>θJA</sub>	0.9	°C/W

**Electrical Characteristics**

(T<sub>A</sub>=25°C Unless otherwise noted)

Parameter	Symbol	Conditions	Min.	Typ	Max.	Unit
<b>Static</b>						
Drain-Source Breakdown Voltage	V <sub>(BR)DSS</sub>	V <sub>GS</sub> =0V, I <sub>D</sub> =250uA	80			V
Gate Threshold Voltage	V <sub>GS(th)</sub>	V <sub>DS</sub> =V <sub>GS</sub> , I <sub>D</sub> =250uA	1.0		2.5	V
Gate Leakage Current	I <sub>GSS</sub>	V <sub>DS</sub> =0V, V <sub>GS</sub> =±20V			±100	nA
Zero Gate Voltage Drain Current	I <sub>DSS</sub>	V <sub>DS</sub> =64V, V <sub>GS</sub> =0V			1	uA
		V <sub>DS</sub> =64V, V <sub>GS</sub> =0V T <sub>J</sub> =85°C			10	
On-State Drain Current	I <sub>D(on)</sub>	V <sub>DS</sub> ≥ 5V, V <sub>GS</sub> =10V	30			A
Drain-Source On-Resistance	R <sub>DS(on)</sub>	V <sub>GS</sub> =10V, I <sub>D</sub> =20A		4.0	5.0	mΩ
		V <sub>GS</sub> =4.5V, I <sub>D</sub> =15A		5.4	6.5	
Forward Transconductance	g <sub>FS</sub>	V <sub>DS</sub> =10V, I <sub>D</sub> =20A		65		S
Diode Forward Voltage	V <sub>SD</sub>	I <sub>S</sub> =5A, V <sub>GS</sub> =0V		0.75	1.2	V
<b>Dynamic</b>						
Total Gate Charge	Q <sub>g</sub>	V <sub>DS</sub> =40V, V <sub>GS</sub> =4.5V I <sub>D</sub> ≡20A		25	50	nC
Gate-Source Charge	Q <sub>gs</sub>			10		
Gate-Drain Charge	Q <sub>gd</sub>			10		
Gate Resistance	R <sub>g</sub>	f=1MHz	0.4	1.4	2.4	Ω
Input Capacitance	C <sub>iss</sub>	V <sub>DS</sub> =40V, V <sub>GS</sub> =0V f=1MHz		2800		pF
Output Capacitance	C <sub>oss</sub>			1100		
Reverse Transfer Capacitance	C <sub>rss</sub>			90		
Turn-On Time	t <sub>d(on)</sub>	V <sub>DD</sub> =40V, R <sub>L</sub> =2.0Ω I <sub>D</sub> ≡20A, V <sub>GEN</sub> =10V R <sub>G</sub> =1Ω		15	30	ns
	t <sub>r</sub>			15	30	
Turn-Off Time	t <sub>d(off)</sub>			30	60	
	t <sub>f</sub>			10	20	



## Typical Characteristics

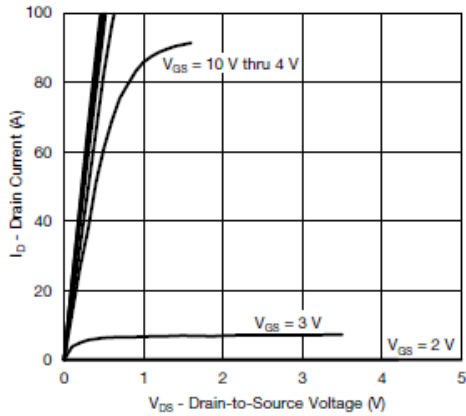

Output Characteristics

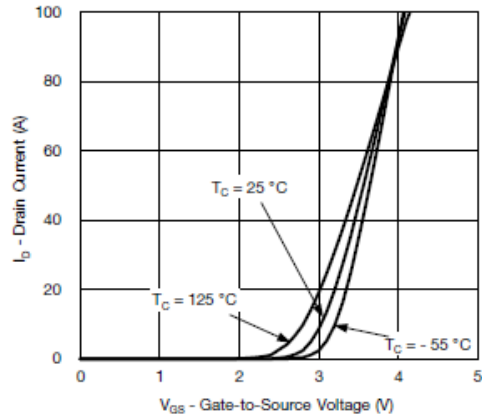

Transfer Characteristics

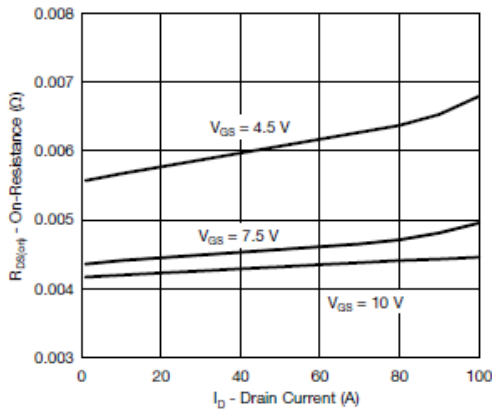

On-Resistance vs. Drain Current

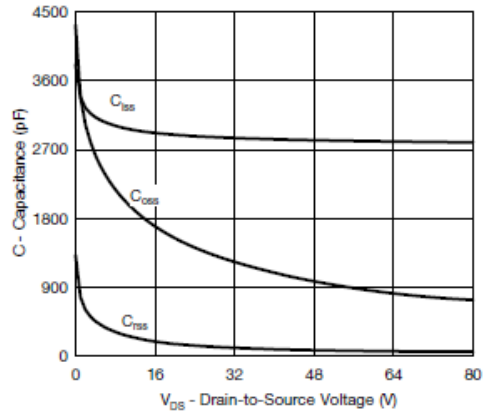

Capacitance

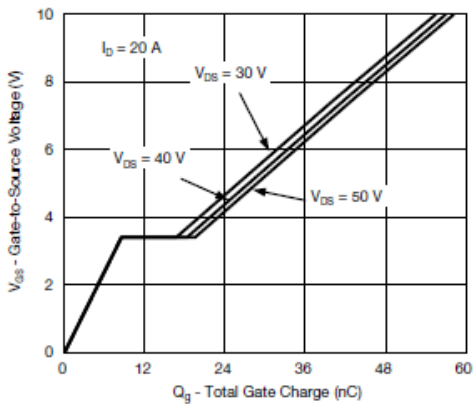

Gate Charge

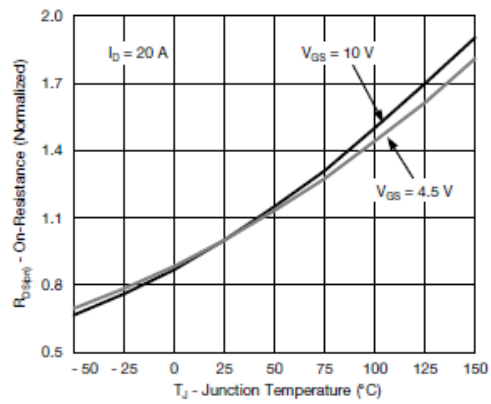

On-Resistance vs. Junction Temperature



**Typical Characteristics**

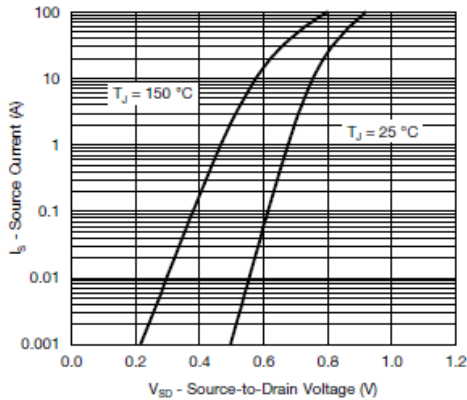

**Source-Drain Diode Forward Voltage**

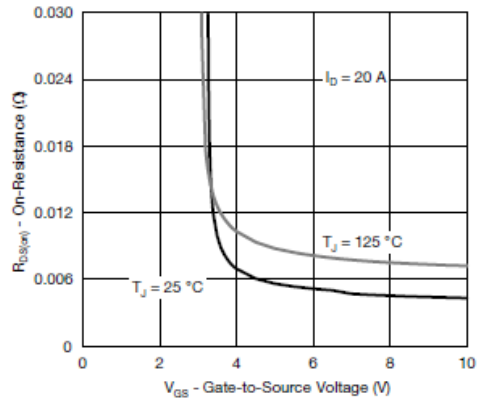

**On-Resistance vs. Gate-to-Source Voltage**

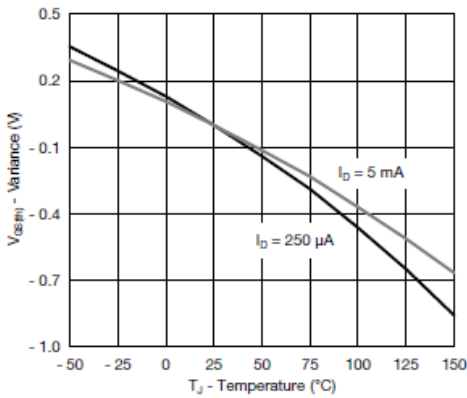

**Threshold Voltage**

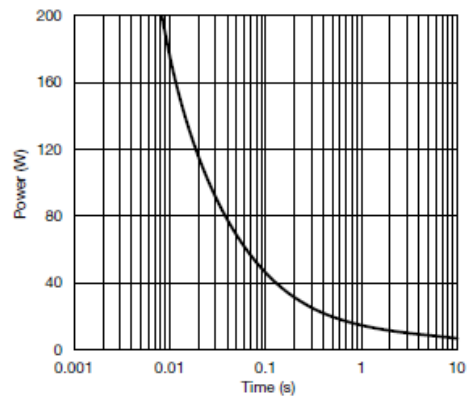

**Single Pulse Power, Junction-to-Ambient**

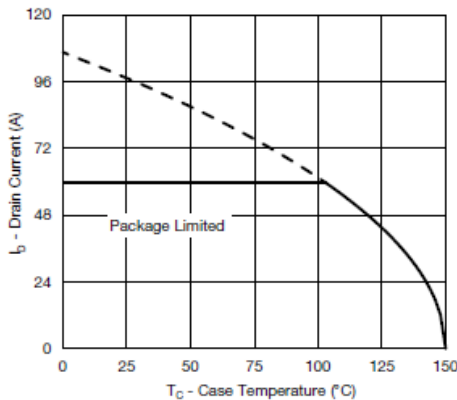

**Current Derating\***

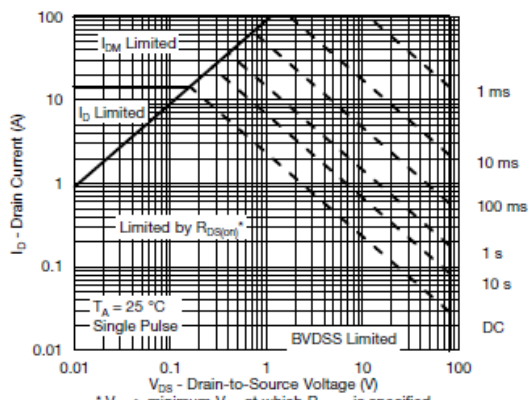

**Safe Operating Area, Junction-to-Ambient**



## Typical Characteristics

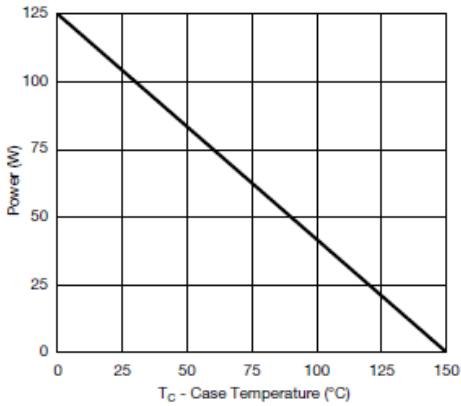

Power, Junction-to-Case

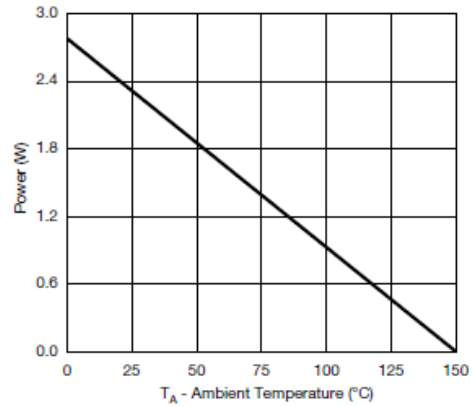

Power, Junction-to-Ambient

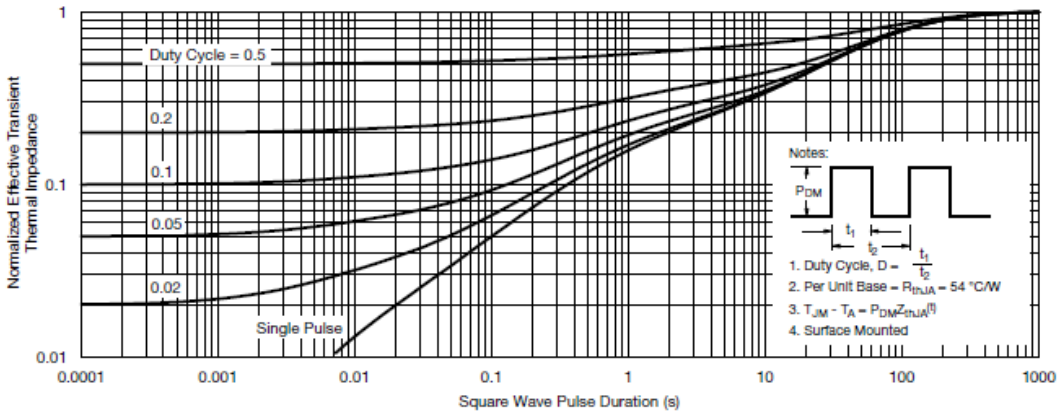

Normalized Thermal Transient Impedance, Junction-to-Ambient

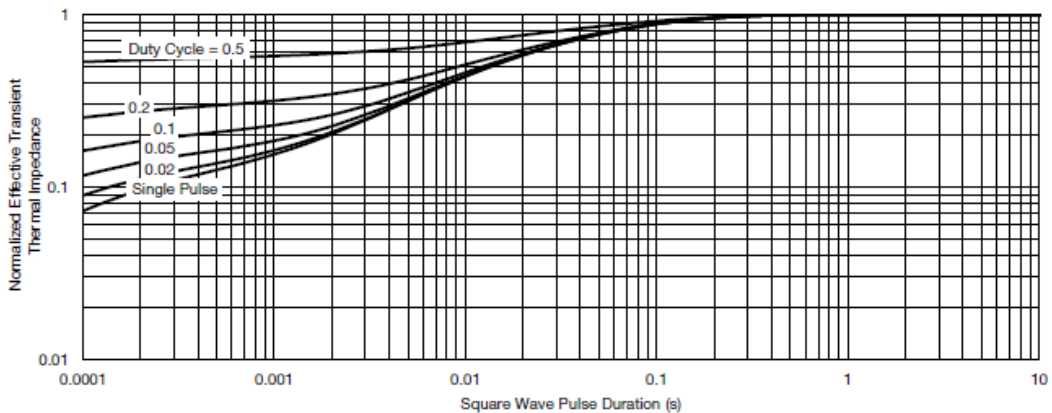

Normalized Thermal Transient Impedance, Junction-to-Case



**Typical Characteristics**

Gate Charge Test Circuit & Waveform

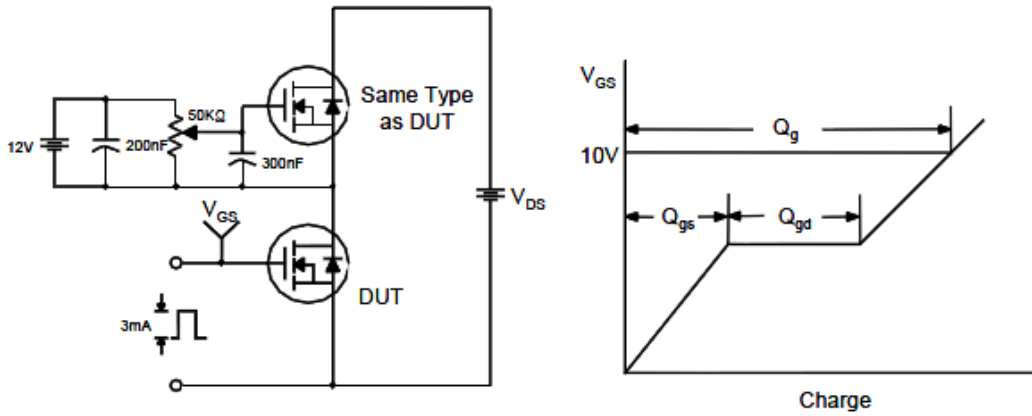

Resistive Switching Test Circuit & Waveforms

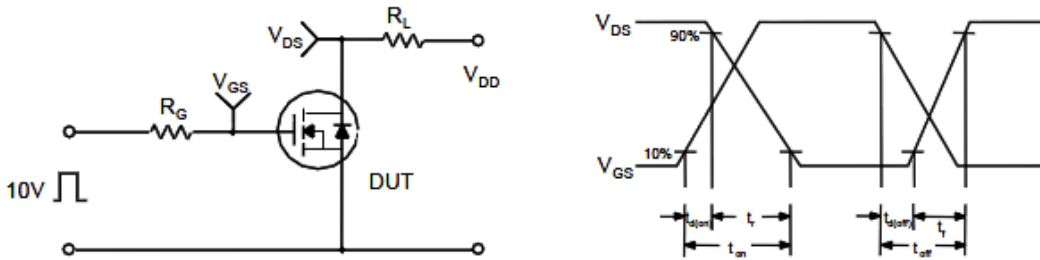

Unclamped Inductive Switching Test Circuit & Waveforms

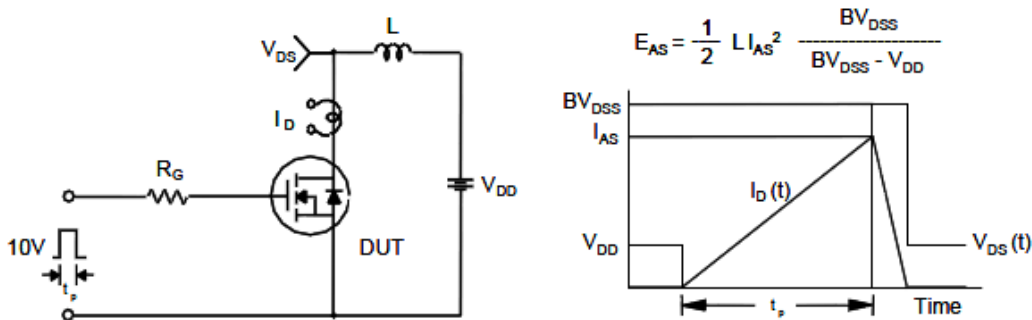



**Package Information ( DFN5X6-8L )**

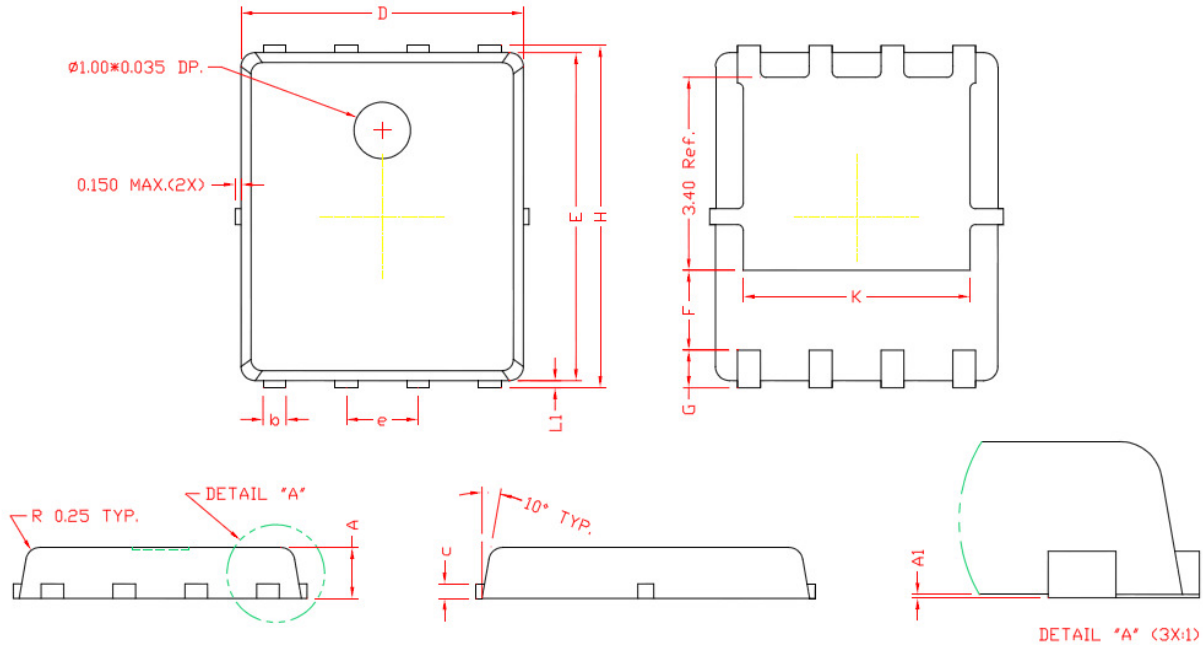

**DIMENSIONS**

REF.	Millimeters		REF.	Millimeters	
	Min.	Max.		Min.	Max.
A	0.80	1.00	E	5.70	5.90
A1	0.00	0.05	e	1.27 BSC.	
b	0.35	0.49	H	5.95	6.20
c	0.254 Ref.		L1	0.10	0.18
D	4.90	5.10	G	0.60 Ref.	
F	1.40 Ref.		K	4.00 Ref.	

©2010 Alfa-MOS Technology Corp.  
2F, No.80, Sec.1, Cheng Kung Rd., Nan Kang Dist., Taipei City 115, Taiwan (R.O.C.)  
Tel : 886 2) 2651 3928  
Fax : 886 2) 2786 8483  
©<http://www.alfa-mos.com>